

OPERATION AND SERVICE MANUAL

MODEL 7620 HypotULTRA®III
MODEL 7650 HypotULTRA®III
Electrical Safety Compliance Analyzer

**AC/DC HIPOT WITH INSULATION RESISTANCE TESTER, CONTINUITY TESTER, AND
USB/RS-232 INTERFACE on 7650**
AC HIPOT WITH CONTINUITY TESTER AND USB/RS-232 INTERFACE on 7620

SERIAL NUMBER

--	--	--	--	--	--	--

Models
7620,7650

Item 38363

Ver 3.07

© Associated Research, Inc. 2014
13860 West Laurel Drive
Lake Forest, Illinois, 60045
U.S.A.
Printed February 24, 2014



DECLARATION OF CONFORMITY

Manufacturer: Associated Research, Inc.
Address: 13860 W. Laurel Dr.
Lake Forest, IL 60045 USA
Product Name: Electrical Safety Compliance Analyzer
Model Number: 7620/7650

Conforms to the following Standards:

Safety: UL 61010-1:2012
CAN/CSA-C22.2 NO. 61010-1-12
UL 61010-2-030:2012
CAN/CSA-C22.2 NO. 61010-2-030-12
EN 61010-1:2010, EN 61010-2-030:2010
EN 61010-031:2002+A1
IEC 61010-1:2010, IEC 61010-2-030:2010
IEC 61010-31:2002+A1

EMC: EN 61326-1:2006
(EN 55011:1998/A2:2002 Class A,
EN 61000-3-2:2006, EN 61000-3-3:1995/ A1:2001/A2:2005
EN 61000-4-2:1995/A2:2000, EN 61000-4-3:2002,
EN 61000-4-4:2004, EN 61000-4-5:1995/A1:2000,
EN 61000-4-6:2003, EN 61000-4-8:1993/A1:2000,
EN 61000-4-11:2004)

Supplementary Information

*The product herewith complies with the requirements of the **Low Voltage Directive 2006/95/EC** and the **EMC Directive 2004/108/EC**.*

Last two digits of the year the CE mark was first affixed: 03

The technical file and other documentation are on file with Associated Research, Inc.

Joseph Guerriero
Vice President / General Manager
Associated Research, Inc.
Lake Forest, Illinois USA
October 30, 2013

TABLE OF CONTENTS

1. INTRODUCTION.....	1
1.1. Warranty.....	1
1.2. Safety Symbols.....	3
1.2.1. Product Marking Symbols.....	3
1.2.2. Caution and Warning Symbols	3
1.3. Glossary of Terms.....	3
1.4. Safety.....	5
1.4.1. Service and Maintenance	5
1.4.2. Test Station.....	6
1.4.3. Test Operator.....	7
1.5. Key Features and Benefits	8
2. GETTING STARTED.....	10
2.1. Unpacking and Inspection	10
2.1.1. Packaging.....	10
2.1.2. Contents of Carton.....	10
2.1.3. Returning the Instrument for Service or Calibration	11
2.2. Installation	11
2.2.1. Work Area	11
2.2.2. Power Requirements.....	12
2.2.3. Basic Connections	12
2.2.4. Environmental Conditions.....	13
3. SPECIFICATIONS AND CONTROLS	14
3.1. Specifications.....	14
3.2. Instrument Controls	20
3.2.1. Front Panel Controls.....	20
3.2.2. Rear Panel Controls	21
4. PROGRAMMING INSTRUCTIONS.....	23
4.1. Power Up.....	23
4.1.1. Memory, Setp and Connected Step Indicator	23
4.1.2. Analog Meters	24
4.1.3. Perform Tests Screen Menu Selections.....	24
4.2. Setup System	25
4.2.1. Setup System Soft keys.....	25
4.2.2. System Parameters	26
4.2.3. Cal Alert (Calibration Alert).....	31
4.2.4. Default System Parameters	34
4.2.5. Memory, Step, and Default System Parameter Initialization	34
4.3. Setup Tests Menu.....	35
4.3.1. Selecting a Memory.....	35
4.3.2. Naming a Memory.....	36

4.3.3. Selecting a Step	36
4.3.4. Test Parameters	37
4.3.5. Default Parameters	39
4.3.6. Setting Up a Test	40
5. OPERATING INSTRUCTIONS	46
5.1. Instrument Connections	46
5.1.1. Connecting the Test Leads	46
5.1.2. Connecting the Adaptor Box	46
5.1.3. Interlock Connector	46
5.2. Performing a Test	47
5.3. Perform Tests Metering	48
5.4. Results Screens	48
5.5. Error Messages	49
6. CONNECTION OF REMOTE I/O	52
6.1. Remote Signal Outputs	52
6.2. Remote Signal Inputs and Memory Access	53
7. BUS REMOTE INTERFACE GPIB / RS-232	56
7.1. RS-232 Interface	56
7.1.1. RS-232 Connector	56
7.1.2. Communications Port Configuration	56
7.1.3. Sending and Receiving Commands	57
7.2. GPIB Interface	57
7.2.1. GPIB Connector	57
7.2.2. GPIB Address	58
7.3. Interface Functions	58
7.4. HypotULTRA III, GPIB / RS-232 Interface Command List	58
7.5. GPIB / RS-232 Interface Command List	59
7.5.1. Rules for Sending Commands to the Instrument	59
7.5.2. Test Execution Commands	59
7.5.3. File Editing Commands	60
7.5.4. Test Parameter Editing Commands and Companion Queries	62
7.5.5. System Parameter Editing Commands and Companion Queries	64
7.5.6. Query Commands	65
7.5.7. IEEE 488.2 Common Commands	67
7.5.8. Status Reporting	69
7.5.9. GPIB Service Request	70
7.6. Example of Communicating Over the GPIB Bus	71
7.7. Non-Volatile Memory	71
8. OPTIONS	72
9. INSTRUMENT VERIFICATION	101
9.1. Verification Initialization	101
9.2. Verification Menu	101

9.2.1. Continuity Verification.....	102
9.2.2. AC Hipot Verification	102
9.2.3. DC Hipot Verification	103
9.2.4. IR Verification	104
10. CALIBRATION.....	106
10.1. Warranty Requirements	106
10.2. Calibration Initialization	107
10.3. Selecting Specific Calibration Points	107
10.4. Calibration of Parameters	107
10.4.1. Calibration of AC Hipot Voltage.....	108
10.4.2. Calibration of DC Hipot Voltage.....	108
10.4.3. Calibration of IR DC Voltage	109
10.4.4. Calibration of 30mA AC Total Current Range	109
10.4.5. Calibration of 3.5mA AC Total Current Range	110
10.4.6. Calibration of 200W/30mA AC Real Current Range	110
10.4.7. Calibration of 20W/30mA AC Real Current Range.....	111
10.4.8. Calibration of 3.5mA AC Total Current Range	111
10.4.9. Calibration of 20W/3.5mA AC Real Current Range	111
10.4.10. Calibration of 3.5mA AC Total Current Range	112
10.4.11. Calibration of 2W/3.500mA AC Real Current Range	112
10.4.12. Calibration of 10mA DC Current Range	112
10.4.13. Calibration of 3.500mA DC Current Range	113
10.4.14. Calibration of 350uA DC Current Range.....	113
10.4.15. Calibration of 999.99M Ω IR Range	114
10.4.16. Calibration of 999.99M Ω IR Range	114
10.4.17. Calibration of 9999.9M Ω IR Range.....	114
10.4.18. Calibration of 50000M Ω IR Range	115
10.4.19. Calibration of Continuity 20 Ω	115
10.4.20. Calibration of Continuity 200 Ω	116
10.4.21. Calibration of Continuity 2000 Ω	117
11. REPLACEMENT PARTS LIST	118
12. SCHEMATIC INDEX	120

1. INTRODUCTION

1.1. Warranty Policies

Associated Research, Inc., certifies that the instrument listed in this manual meets or exceeds published manufacturing specifications. This instrument was calibrated using standards that are traceable to the National Institute of Standards and Technology (NIST).

Your new instrument is warranted to be free from defects in workmanship and material for a period of (2) year from the date of shipment. You must complete the online registration at <http://www.asresearch.com/support/register/login.aspx> or call 1-800-858-TEST (8378) ext. 0 to register over the phone.

5-Year Program

All Associated Research instruments include the opportunity to extend the standard warranty for up to a period of 5 years. Returning instruments to Associated Research for their annual calibration and inspection will extend the instrument's warranty for an additional year. This warranty is extendable for up to five years and annual returns must be made in succession starting one year after the original purchase date. There are no additional costs for the 5 year product warranty. The only annual costs to the customer are the standard calibration fees and shipping costs. This extended warranty is non-transferable and is offered only to the original purchaser. A return material authorization (RMA) must be obtained from Associated Research, Inc. before returning this instrument for warranty service. Please contact our customer support center at 1-800-858-TEST (8378) to obtain an RMA number. It is important that the instrument is packed properly for safe transport. Please contact our customer support center for proper instructions on packaging. Damages sustained as a result of improper packaging will not be honored. Transportation costs for the return of the instrument for warranty service must be prepaid by the customer. Associated Research, Inc. will assume the return freight costs when returning the instrument to the customer. The return method will be at the discretion of Associated Research, Inc.

3-Year Program

A 3-Year warranty is also available for instruments purchased and used in North America. All costs for this warranty are paid with the initial purchase and include warranty coverage, annual recertification and standard ground return freight for **(3) Years**. However, unlike our 5-Year program, annual recertification and inspection by Associated Research, Inc. is not required.

Except as provided herein, Associated Research, Inc. makes no warranties to the purchaser of this instrument and all other warranties, express or implied (including, without limitation, merchantability or fitness for a particular purpose) are hereby excluded, disclaimed and waived.

Operator Modifications

Any non-authorized modifications, tampering or physical damage will void this warranty. Elimination of any connections in the earth grounding system or bypassing any safety systems will void this warranty. This warranty does not cover accessories not of Associated Research, Inc. manufacture. Parts used must be parts that are recommended by Associated Research, Inc. as an acceptable specified part. Use of non-authorized parts in the repair of this instrument will void the warranty.

Associated Research, Inc. will not be responsible for any injuries sustained due to unauthorized equipment modifications or use of parts not specified by Associated Research, Inc. Instruments returned to Associated Research, Inc. with unsafe modifications will be returned to their original operating condition at the customer's expense.

1.2. Safety Symbols

1.2.1. Product Marking Symbols



Product will be marked with this symbol when it is necessary to refer to the operation and service manual in order to prevent injury or equipment damage.



Product will be marked with this symbol when hazardous voltages may be present.



Product will be marked with this symbol at connections that require earth grounding.

1.2.2. Caution and Warning Symbols



Calls attention to a procedure, practice, or condition that could possibly cause bodily injury or death.



Calls attention to a procedure, practice, or condition that could possibly cause damage to equipment or permanent loss of data.

1.3. Glossary of Terms

(As used in this manual)

Alternating Current, AC: Current that reverses direction on a regular basis. Utility power is usually generated in the form of a sinusoid at a frequency of 60 times per second in the United States and 50 times per second in other countries.

Arc: A partial momentary breakdown due to the force of a strong electric field on closely spaced conductors, sometimes evidenced by corona or a luminous flashover.

Breakdown: The failure of insulation to effectively prevent the flow of current. If the test voltage is gradually raised, breakdown will begin suddenly at a certain voltage level and current flow will not be directly proportional to voltage. Once a breakdown occurs, especially for a period of time, the next gradual application of voltage will often cause a breakdown to begin at a lower voltage.

Conductor: A solid or liquid material which permits the flow of electrons. A material which has a volume resistivity of no more than $10^3 \Omega\text{-cm}$.

Current: The movement of electrons through a conductor. Current is measured in amperes (A), milliamperes (mA), microamperes (uA). Symbol = I

Dielectric: An insulating material that is positioned between two conductive materials in such a way that a charge or voltage may appear across the two conductive materials.

Direct Current, DC: Current that flows in one direction only. The source of direct current is said to be polarized and has one terminal that is always at a higher potential than the other.

Frequency: The number of cycles an AC waveform repeats over time. Usually given in Hertz (Hz).

Ground: Refers to the point of low potential in a circuit to which all other voltages are referenced. May or may not be tied to the earth. Also referred to as Earth.

Hot: Used to refer to the test lead or output side of an instrument that is at high potential.

Impedance: The property of capacitive or inductive items to limit certain frequencies.

Insulation: Gas, liquid or solid material which has a volume resistivity of at least 10^{12} Ω -cm and is used for the purpose of restricting current flow between conductors.

Leakage: AC or DC current flow through insulation and over its surfaces. Current flow is directly proportional to voltage. The insulation is thought of as a constant impedance unless breakdown occurs.

Neutral: The point of low potential in a circuit to which all other voltages are referenced. Also known as Common.

Peak Current: The maximum amplitude of an AC current waveform. For a sinusoid, 1.414 x the RMS value.

Power: The amount of work performed by an energy source over time, given in Watts (W).

PF (Power factor): Power Factor = W/VA where W =Watts (Real Power) and VA =Volts x Amps (apparent power). It is important to note that the closer the power factor is to "1" the more resistive the DUT is. The closer the power factor is to 0 the more reactive (inductive or capacitive) the DUT is.

Reactive Current: The current component due to the reactive impedance of a load. Also called imaginary current.

Real Current: The current component due to the resistance of a load.

Resistance: The property of a substance that impedes current and results in the dissipation of power in the form of heat. The practical unit of resistance is the *ohm* (Ω). Symbol = **R**

Return: The path by which current returns to a source.

RMS: The Root Mean Squared value of a voltage or current waveform. An RMS waveform delivers the same amount of energy to a load as a DC waveform of the same value. For a sinusoid, the RMS value is .707 x the peak value.

Total Current: The vector sum of the real current component and the reactive current component produced by an applied voltage.

VA: A rating of instantaneous power found by multiplying an instrument's maximum output current by its maximum output voltage.

Voltage: The force which causes current through an electrical conductor, given in volts (V). Symbol = **V**

1.4. Safety

This product and its related documentation must be reviewed for familiarization with safety markings and instructions before operation.

This product is a Safety Class I instrument (provided with a protective earth terminal). Before applying power verify that the input voltage to the instrument is 115VAC±10% or 230VAC±10% and the correct fuse is installed.

This product carries an NRTL (Nationally Recognized Testing Laboratory) and comes equipped with an audible and visual failure indicator.

WARNING

The HypotULTRA III produces voltages and currents that can cause **harmful or fatal electric shock**. To prevent accidental injury or death, these safety procedures must be strictly observed when handling and using the test instrument.

1.4.1. Service and Maintenance

User Service

To prevent electric shock do not remove the instrument cover. There are no internal user serviceable parts. Routine maintenance or cleaning of internal parts is not necessary. Avoid the use of cleaning agents or chemicals on the instrument, as some chemicals may damage plastic parts or lettering. Any external cleaning should be done with a clean, dry or slightly damp cloth. Schematics, when provided, are for reference only. Refer servicing and certification to an Associated Research, Inc. authorized service center.

SAFETY

This instrument meets UL requirements for audible and visual failure indication.

ASSOCIATED RESEARCH, INC.
13860 WEST LAUREL DRIVE
LAKE FOREST, IL 60045-4546 U.S.A.

PHONE: 1 (847) 367-4077
1 (800) 858-TEST (8378)
FAX: 1 (847) 367-4080
E-MAIL: info@asresearch.com

Service Interval

Associated Research, Inc. will not be held liable for injuries suffered if the instrument is not properly maintained and safety checked annually. See section 1.1. **Warranty Policies** for more information.

1.4.2. Test Station

Location

Select an area away from the mainstream of activity where employees do not walk while performing their normal duties. If this is not practical because of production line flow, then the area should be roped off and marked for **HIGH VOLTAGE TESTING**. No employees other than test operators should be allowed inside.

If benches are placed back-to-back, be especially careful about the use of the bench opposite the test station. Signs should be posted: **“DANGER – HIGH VOLTAGE TEST IN PROGRESS – UNAUTHORIZED PERSONNEL KEEP AWAY.”**

Work Area

When possible, use the instrument on a non-conducting table or workbench. If you cannot avoid using a conductive surface, be certain that it is connected to a good earth ground and the high voltage connection is insulated from the grounded surface.

There should not be any metal in the work area between the operator and the location where products being tested will be positioned. Any other metal in the work area should be connected to a good ground, never left “floating”.

Keep the area clean and uncluttered. All test equipment and unnecessary test leads should be removed from the test bench and put away. It should be apparent to both the operator and to any observers which product is under test, which product is waiting to be tested and which product has already been tested.

Power

Power to the test station should be arranged so that it can be shut off by one prominently marked switch located at the entrance to the test area. In case of an emergency, anyone should be able to cut off the power before entering the test area to offer assistance.

More Information

For more information on setting up a safe work station, please visit the Events and Training section of our website at <http://www.asresearch.com/events-training/Default.aspx>

ESD TESTING

Electrical safety tests should not be performed in or around ESD testing areas. ESD methods should not be employed during electrical safety testing, as this could cause a hazardous condition for equipment and test operators.

1.4.3. Test Operator

WARNING

This instrument generates voltages and currents that can cause **harmful or fatal electric shock** and must only be operated by a skilled worker trained in its use. **The operator should understand the electrical fundamentals of voltage, current, and resistance.**

WARNING

Do not touch the device under test, high voltage test lead, alligator clip, or clip insulator once the test has been started.

WARNING

Do not touch the front panel when testing or after a malfunction has occurred.

Rules

Operators should be thoroughly trained to follow all national safety standard guidelines for electrical safety testing in the workplace. Defeating any safety system should be considered a serious offense with severe penalties. Allowing unauthorized personnel in the area during a test should also be dealt with as a serious offense. Test operators should be familiar with methods to properly discharge a device under test in case test leads become disconnected during testing.

Refer to the following standards for more information:

- NFPA 70E
- OSHA 1910 subpart (S)
- EN50191

Dress

Operators should not wear jewelry that could accidentally complete a circuit.

WARNING

ESD protocols should not be observed while performing electrical safety tests. Intentionally grounding the test operator could lead to a **harmful or fatal electric shock**.

Medical Restrictions

Personnel with heart ailments or devices such as pacemakers should be informed that the voltages and currents generated by the instrument are very dangerous. If contacted, the instrument may cause heart-related problems. Please have the test operator consult a physician for recommendations.

KEY SAFETY POINTS TO REMEMBER

- Keep unqualified and unauthorized personnel away from the test area.
- Arrange the test station in a safe and orderly manner.
- In case of any problem, turn off the high voltage first.

Key Features of the HypotULTRA III

CAL-ALERT™	Alerts the operator that the machine is due for calibration in advance of the calibration due date.
TWO CONTINUITY TEST MODES	Two test modes allow for a basic Continuity test to be performed simultaneously with the Hipot test, or a stand-alone Continuity test to be performed independently for higher resistance and point-to-point applications.
PATENTED SMARTGFI™	SmartGFI™ disables the instrument's output voltage in less than 1 millisecond if excessive leakage to ground is detected. If enabled, SmartGFI™ automatically detects if the DUT is floating or grounding and turns ON or OFF accordingly.
SECURITY ACCESS	Allows the operator to set different levels of access to the instrument's setup programs. Users can setup passwords for restricting access to certain parts of the menu.
50 PROGRAMMABLE TEST SETUPS WITH 30 STEPS PER SETUP	Each test setup can store up to 30 steps which can be configured to perform any of the safety tests. Each setup can be named for easy identification and recall.
REAL CURRENT MEASUREMENT	HypotULTRA III simultaneously monitors real and total current in AC Hipot mode on the same screen.
EXCLUSIVE PROMPT AND HOLD FUNCTION	HypotULTRA III allows operators to setup a user-configured message that is displayed in between test steps. This is a very convenient feature for applications where test leads need to be moved or when DUT switches need to be activated as part of the test cycle.
DIGITALLY CONTROLLED ARC DETECTION SYSTEM	Allows the operator to choose whether low-level arcs should be detected. The operator can select from multiple sensitivity levels.
ELECTRONIC RAMPING (UP AND DOWN)	Allows the operator to linearly increase or decrease the output voltage to the DUT over a specified period of time. Minimizes any damage to sensitive DUT's from quick high voltage changes.

PLC REMOTE INPUTS & OUTPUTS	Two standard 9 pin interfaces provide outputs for PASS, FAIL, RESET and TEST IN PROCESS signals. Inputs include TEST, INTERLOCK, RESET and remote recall of MEMORIES 1 - 10. Provides the user with the ability to operate the HypotULTRA III through simple PLC relay control.
VERI-CHEK™	Allows the operator to self-verify the instrument's failure detectors.

2. GETTING STARTED

Introduction

This section contains information for the unpacking, inspection, preparation for use and storage of your Associated Research, Inc., product.

2.1. Unpacking and Inspection

2.1.1. Packaging

Your instrument was shipped in a custom foam insulated container. If the shipping carton is damaged, inspect the contents for visible damage such as dents, scratches or a broken display. If the instrument is damaged, notify the carrier and Associated Research, Inc.'s customer support department. **Please save the shipping carton and packing material for the carrier's inspection.** Our customer support department will assist you in the repair or replacement of your instrument. Please do not return your product without first notifying us and receiving an RMA (return material authorization) number. To receive an RMA number, please contact our customer support department at 1-800-858-TEST (8378).

- **NOTE:** Please retain all of the original packaging materials.

2.1.2. Contents of the Carton

Inside the carton should be the following:

DESCRIPTION	AR PART NUMBER
HypotULTRA III Instrument	7650 or 7620
High Voltage Cable	04040A-08
Return Cable	02100A-13 (Qty.2)
USB/RS-232 Card	39063
Fuse	38388
Line Cord*	33189 Standard
Adapter Box*	36544 Standard
2U Rack Mount Handle	38794 (Qty 2)
2U Rack Mount Bracket	38793 (Qty 2)
Screw M4 x 12mm FHMS	38549 (Qty 4) For Rack Mount Handle
Interlock Connector	38075

- **NOTE:** The Adapter Box (universal US polarity) and line cord listed are American. Other combinations of line cord and Adapter Box are available upon request.

WARNING

Only accessories which meet the manufacturer's specification shall be used.



2.1.3. Returning the Instrument for Service or Certification

When it is necessary to return the instrument for servicing or certification, repackage the instrument in its original container as long as it is in good condition. Please include all accessories and test leads. Mark the container “FRAGILE” to ensure proper handling. Before shipping, contact an Associated Research, Inc. customer support representative at 1-800-858-TEST (8378) to indicate and explain the reason for service. At this time you will be supplied with an RMA (return material authorization) number. Please refer to this number in all correspondence.

If you do not have the original packaging materials, please follow these guidelines:

- Wrap the instrument securely in a heavy duty bubble pack or similar foam. Enclose the same items as above.
- Use a strong double-wall container that is made for shipping instrumentation. 350-lb. test material is adequate.
- Use a layer of shock-absorbing material 70 to 100 mm (3 to 4 inch) thick around all sides of the instrument. Protect the control panel with cardboard.
- Seal the container securely.
- Mark the container “FRAGILE” to insure proper handling.
- Please refer in all correspondence to your RMA number.
- **Do not ship more than 1 unit per box.**

2.2. Installation

2.2.1. Work Area



Locate a suitable testing area and be sure you have read all safety instructions for the operation of the instrument and suggestions on the test area setup in section **1.4. Safety**.

Make sure the work area you choose has a three-prong grounded outlet capable of supplying the necessary input current to the power source. Be sure the outlet has been tested for proper wiring before connecting the instrument to it.

WARNING

The mains plug is used as the disconnecting device and shall remain readily operable. The socket-outlet shall be installed near the equipment and shall be easily accessible.

2.2.2. Power Requirements

This instrument requires a power source of either 115 volts AC \pm 10%, 50/60 Hz single phase or 230 volts AC \pm 10%, 50/60 Hz single phase. Before applying power verify that the instrument is set to the correct line voltage (115 or 230 volts). Adjust the voltage select switch to 115 for use with a 115 volt input. Adjust the voltage select switch to 230 for use with a 230 volt input. See section **3.2.2. Rear Panel Controls** for an image of the rear panel.

CAUTION

Do not replace the power supply cord with an improperly rated cord. For North American: A UL listed and CSA labeled power cord must be used with the instrument in the United States and Canada. The power cord must include a NEMA5-15 style male plug, SVT or SJT cord sets, and be rated for at least 125VAC, 10A, number 16 gauge (or 125VAC, 15A, number 14 gauge) wire or larger, and the length of the cord does not exceed 2 m must be used. For European: A certified power supply cord not lighter than light PVC sheathed flexible cord according to IEC 60227, designation H03 VV-F or H03 VVH2-F (for equipment mass not exceeding 3 kg), or H05 VV-F or H05 VVH2-F2 (for equipment mass exceeding 3 kg), and be rated for at least 3G 0.75 mm² (for rated current up to 10 A) or 3G 1.0mm² (for rated current over 10 A up to 16 A) wire or larger, and the length of the cord does not exceed 2 m must be used.

CAUTION

Do not switch the line voltage selector switch located on the rear panel while the instrument is on or operating. This may cause internal damage and represents a safety risk to the operator.

WARNING

The HypotULTRA III must be connected to a good ground. Be certain that the power wiring is properly polarized and that the proper low resistance bonding to ground is in place.

2.2.3. Basic Connections

Power Cable

The instrument is shipped with a line cord containing a protective earth ground. When the line cord is connected to an appropriate AC power source the cable will connect the chassis to earth ground.

WARNING

The main plug shall only be inserted in a socket outlet with a protective ground (earth) contact. This protective ground **must**

not be defeated by the use of an extension cord without a protective conductor.

Return Connection

When the instrument's return is grounded, any internal and external stray leakage will be monitored due to currents that flow from high voltage to earth ground (such as from high voltage to the chassis of the instrument). These currents are inherent and will cause errors when trying to monitor very low leakage currents in the microamp range.

The output power supplies of this instrument are referenced directly to earth ground. Any conductor that completes a path between the high voltage and earth ground will form a completed circuit.

Environmental Conditions

This equipment is intended for indoor use only. The equipment has been evaluated according to Installation Category II and Pollution Degree 2 as specified in IEC 664.

This instrument may be operated in environments with the following limits:

Temperature.....	41° - 104° F (5° - 40°C)
Relative humidity.....	0 – 80%
Altitude.....	6560 feet (2,000 meters)



Keep the ventilation slits uncovered during operation. Failure to do so could cause the instrument to overheat and may damage internal components.

Storage and Shipping Environment

This instrument may be stored or shipped in environments with the following limits:

Temperature.....	-40° - 167° F (-40° - 75°C)
Altitude.....	50,000 feet (15,240 meters)

The instrument should also be protected against temperature extremes that may cause condensation within the instrument.



Failure to operate this instrument within the specified conditions could result in damage.

If the instrument is used in a manner not specified by the manufacturer, the protection provided by the instrument may be impaired.

More Information

For more information on test operator and workstation safety please visit the Events and Training section of our website at <http://www.asresearch.com/events-training/Default.aspx>

3. SPECIFICATIONS AND CONTROLS

3.1. HypotULTRA III Functional Specifications, 7620 and 7650

INPUT	
Voltage	115 / 230 VAC \pm 10 %, automatically selected
Frequency	50/60 Hz \pm 5%
Fuse	4 Amp 250V Slo-Blo
DIELECTRIC WITHSTAND TEST MODE	
Output Rating	5 KV @ 30 mA AC
	5 KV @ 10 mA DC for 7650 only
Output Adjustment	Range: 0 – 5000V AC 0 – 5000V DC for 7650 only Resolution: 1 Volt Accuracy: \pm (2% of setting + 5 volts) (Can be adjusted during operation. Disabled when key lockout is active.)
Ramp-HI	12mA peak maximum, ON/OFF selectable
Charge-LO	Range: 0.0 – 350.0 μ A DC or Auto set
Max and Min-Limit	
AC Total	Range 1: 0.000 – 9.999mA Resolution: 0.001mA Range 2: 10.00 – 30.00 mA Resolution: 0.01 mA Accuracy: \pm (2% of setting + 2 counts)
AC Real	Range 1: 0.000 – 9.999mA Resolution: 0.001mA Range 2: 10.00 – 30.00 mA Resolution: 0.01 mA Accuracy: \pm (3% of setting + 0.05mA) All Ranges PF > 0.1 V > 250VAC

DIELECTRIC WITHSTAND TEST MODE	
DC (for 7650 only)	Range 1: 0.0 – 999.9 μ A Resolution: 0.1 μ A Range 2: 1000 – 10000 μ A Resolution: 1 μ A Accuracy: \pm (2% of setting + 2 counts)
Arc Detection	Range: 1 – 9
Failure Detector	Audible and Visual
Voltage Display	Range: 0.00 – 5.00 KV Full Scale Resolution: 10 volts Accuracy: \pm (2% of setting + 2 counts)
Current Display	Auto Range
AC Total	Range 1: 0.000mA – 3.500mA Resolution: 0.001mA Range 2: 3.00 – 30.00 mA Resolution: 0.01 mA Accuracy: \pm (2% of reading + 2 counts)
AC Real	Range : 0.000mA – 30.00mA Resolution: 0.001mA or 0.01mA Accuracy: \pm (3% of reading + 0.05mA) All Ranges PF > 0.1 V > 250VAC
DC	Range 1: 0.0 μ A – 350.0 μ A for 7650 only Resolution: 0.1 μ A Range 2: 0.300 mA – 3.500 mA for 7650 only Resolution: 0.001mA Range 3: 3.00 mA – 9.99 mA for 7650 only Resolution: 0.01mA Accuracy: \pm (2% of reading + 2 counts)
DC Output Ripple	\leq 4% Ripple RMS at 5 KV DC @ 10 mA, Resistive Load
Discharge Time	\leq 200 ms

DIELECTRIC WITHSTAND TEST MODE																			
Maximum Capacitive Load in DC Mode	<table border="0"> <tr> <td>1uF----< 1KV</td> <td>0.08uF----< 4KV</td> </tr> <tr> <td>0.75uF----< 2KV</td> <td>0.04uF----< 5KV</td> </tr> <tr> <td>0.5uF----< 3KV</td> <td></td> </tr> </table>	1uF----< 1KV	0.08uF----< 4KV	0.75uF----< 2KV	0.04uF----< 5KV	0.5uF----< 3KV													
1uF----< 1KV	0.08uF----< 4KV																		
0.75uF----< 2KV	0.04uF----< 5KV																		
0.5uF----< 3KV																			
AC Output Wave Form	Sine Wave, Crest Factor = 1.3 – 1.5																		
Output Frequency	Range: 60 or 50 Hz, User Selection Accuracy: ± 0.1%																		
Output Regulation	± (1 % of output + 5 V) From no load to full load and over input voltage range																		
Dwell Timer	Range: 0.0, 0.4 – 999.9 sec (0 = Continuous) Resolution: 0.1 sec Accuracy: ± (0.1% + 0.05 sec)																		
Ramp Timer	<table border="0"> <tr> <td>Range:</td> <td>Ramp-Up:</td> <td>0.1 – 999.9 sec</td> </tr> <tr> <td></td> <td>Ramp-Down:</td> <td>AC 0.0 – 999.9 sec</td> </tr> <tr> <td></td> <td></td> <td>DC 0.0, 0.1 – 999.9 sec</td> </tr> <tr> <td></td> <td></td> <td>0.0=OFF</td> </tr> <tr> <td>Resolution:</td> <td colspan="2">0.1 sec</td> </tr> <tr> <td>Accuracy:</td> <td colspan="2">± (0.1% + 0.05 sec)</td> </tr> </table>	Range:	Ramp-Up:	0.1 – 999.9 sec		Ramp-Down:	AC 0.0 – 999.9 sec			DC 0.0, 0.1 – 999.9 sec			0.0=OFF	Resolution:	0.1 sec		Accuracy:	± (0.1% + 0.05 sec)	
Range:	Ramp-Up:	0.1 – 999.9 sec																	
	Ramp-Down:	AC 0.0 – 999.9 sec																	
		DC 0.0, 0.1 – 999.9 sec																	
		0.0=OFF																	
Resolution:	0.1 sec																		
Accuracy:	± (0.1% + 0.05 sec)																		
Ground Continuity	Current: DC 0.1 A ± 0.01A, fixed Max. ground resistance: 1 Ω ± 0.1Ω, fixed																		
Ground Fault Interrupt	GFI Trip Current: 450 uA max (AC or DC) HV Shut Down Speed: < 1ms																		
INSULATION RESISTANCE TEST MODE, MODEL 7650 ONLY																			
Output Voltage	Range: 50 – 1000 Volts DC Resolution: 1 Volt Accuracy: ± (2% of reading + 2 volts)																		
Short Circuit Current	Maximum: 12mA peak																		
Voltage Display	Range: 0 – 1000 V Resolution: 1 Volt Accuracy: ± (2% of reading + 2 counts)																		

INSULATION RESISTANCE TEST MODE, MODEL 7650 ONLY				
Resistance Display	Range:	0.05M Ω – 50000 M Ω (5 Digit, Auto Ranging)		
	Resolution:		500VDC	1000VDC
		M Ω	M Ω	M Ω
	0.001	0.050 – 9.999	0.100 – 9.999	
	0.01	1.00 – 99.99		1.00 – 99.99
	0.1	10.0 – 999.9		10.0 – 999.9
	1	100 – 50000		100 – 50000
	Accuracy:	50 – 499V 0.05M Ω – 999.9M Ω , \pm (7% of reading + 2 counts)		
		500 – 1000V 0.10M Ω – 999.9M Ω , \pm (2% of reading + 2 counts) 1000M Ω – 9999M Ω , \pm (5% of reading + 2 counts) 10000M Ω – 50000M Ω , \pm (15% of reading + 2 counts)		
Charge-LO	Range:	0.000 – 3.500 μ A or Auto Set		
Maximum and Minimum Limits	Range:	0.0, 0.05M Ω – 99.99M Ω		
	Resolution:	0.01M Ω		
	Range:	100.0M Ω – 999.9M Ω		
	Resolution:	0.1M Ω		
	Range:	1000M Ω – 50000M Ω		
	Resolution:	1M Ω		
	(Max Limit: 0 = OFF)			
	Accuracy:	Same as Resistance Display Accuracy		
Ramp Timer	Range:	Ramp-Up: 0.1 – 999.9 sec Ramp-Down: 0.0, 1.0 – 999.9 sec		
	Resolution:	0.1 sec		
	Accuracy:	\pm (0.1% + 0.05 sec)		
Delay Timer	Range:	0.0, 1.0 – 999.9 sec 0 = Continuous		
	Resolution:	0.1 sec		
	Accuracy:	\pm (0.1% + 0.05 sec)		
Ground Fault Interrupt	GFI Trip Current:	450 uA max		
	HV Shut Down Speed:	< 1ms		

CONTINUITY TEST MODE	
Output Current	DC 0.1A \pm 0.01A Total Resistance*: 0.00-33.0 Ω DC 0.01A \pm 0.001A Total Resistance*: 31.0-330 Ω DC 0.001A \pm 0.0001A Total Resistance*: 310-2000 Ω
Resistance Display	Range 1: 0.00 – 19.99 Ω Resolution: 0.01 Ω Accuracy: \pm (1 % of reading + 0.05 Ω) Range 2: 20.0 – 199.9 Ω Resolution: 0.1 Ω Accuracy: \pm (1 % of reading + 0.2 Ω) Range 3: 200 – 2000 Ω Resolution: 1 Ω Accuracy: \pm (1 % of reading + 2 Ω)
Maximum and Minimum Limits	Range 1: 0.00 – 99.99 Ω Resolution: 0.01 Ω Accuracy: \pm (1% of setting+0.05 Ω) Range 2: 100.0 – 999.9 Ω Resolution: 0.1 Ω Accuracy: \pm (1% of setting+0.2 Ω) Range 3: 1000 – 2000 Ω Resolution: 1 Ω Accuracy: \pm (1% of setting+2 Ω) (Max Limit: 0 = OFF)
Dwell Timer	Range: 0.0, 0.3 – 999.9 sec (0 = Continuous) Resolution: 0.1 sec Accuracy: \pm (0.1% + 0.05 sec)
Milliohm Offset	Range: 0.00 – 10.00 Ω Resolution: 0.01 Ω Accuracy: \pm (1 % of reading + 0.05 Ω)

- Total Resistance includes resistance of Test leads, Fixture, and DUT.

GENERAL SPECIFICATIONS	
PLC Remote Control	Input: Test, Reset, Interlock, Recall Memory 1 through 10
	Output: Pass, Fail, Test-in-Process, Reset
Remote Output Relays	125VAC@1AAC, 30VDC@ 0.5ADC
Safety	Built-in Smart GFI circuit
Memory	50 memories, 30 steps/memory
Interface	Standard USB/RS-232, Optional GPIB, Ethernet or Printer Port with Date and Time Stamp.
Security	Programmable password lockout capability to avoid unauthorized access to test set-up program.
Graphic Display	240 x 64 dot resolution. Monographic LCD
Alarm Volume	Range: 0 – 9; 0 = OFF, 1 is softest volume, 9 is loudest volume.
Contrast	Range: 1 – 9; 1 is lightest character, 9 is darkest character.
Calibration	Adjustments are made through the front panel. Built-in Verification program. Automatic Calibration alert function to signal operator when calibration is due.
Environmental	Temperature: 0 – 40°C Humidity: 0 – 80%
Mechanical	Bench or rack mount (2U height) with tilt up front feet Dimensions:(w x h x d) 16.92x3.50x15.75in (430x89x400mm)
Weight	31.38 Lbs (14.23 kgs) variable with options

OPTIONS	
Scanning Matrix	4 or 8 port high voltage switching matrix with continuity.

3.2. Instrument Controls

3.2.1. Front Panel Controls

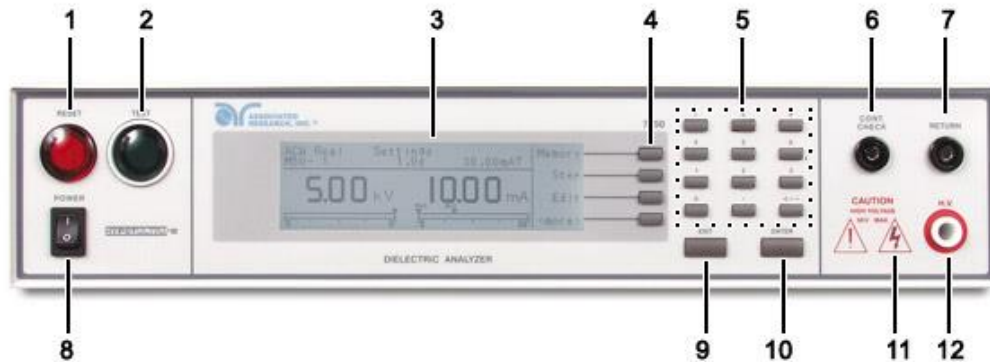

- 1. RESET BUTTON:** Resets the instrument. If a failure condition occurs during a test, pressing this button will reset the system, shut off the alarm and clear the failure condition. The Reset button must be pressed before performing another test or changing any of the setup parameters. This button also serves as an abort signal to stop any test in progress.
- 2. TEST BUTTON:** Starts a test.
- 3. GRAPHIC LCD:** 240 X 64 Monographic LCD.
- 4. SOFT KEYS:** Multifunction keys used to select screens and change parameters.
- 5. NUMERIC DATA ENTRY:** Keys used to enter numeric data.
- 6. CONTINUITY OUTPUT TERMINAL:** Connector used to attach the return test lead, adaptor box return lead, or test fixture return lead used during Continuity testing.
- 7. RETURN OUTPUT TERMINAL:** Connector used to attach the return test lead, adaptor box return lead or test fixture return lead to the instrument. This connection provides the return current path.
- 8. POWER SWITCH:** Turns the Hipot tester ON or OFF.
- 9. EXIT KEY:** Key used to escape from parameter editing and return to prior screens.
- 10. ENTER KEY:** Key used to finalize parameter entries. The ENTER key may also be used to scroll the highlighted area to different parameters in the parameter setting screens.

11. HIGH VOLTAGE INDICATOR: This indicator flashes to warn the operator that high voltage is present at the high voltage output terminal.

12. HIGH VOLTAGE OUTPUT TERMINAL: Connector used to attach the high voltage test lead, adapter box high voltage lead or test fixture high voltage lead to the instrument. This connection provides the high voltage used during a Hipot test.

3.2.2. Rear Panel Controls

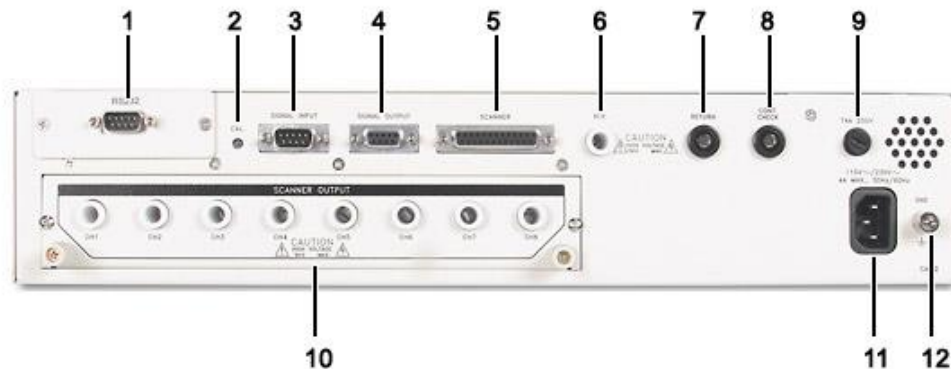

1. **BUS INTERFACE:** Standard connector for interconnection to the USB/RS-232 Bus interface. Optional IEEE 488 or Ethernet interface may be substituted for the USB/RS-232.
2. **CALIBRATION BUTTON:** To put the instrument into the calibration mode push this button and turn on the power switch simultaneously.
3. **REMOTE SIGNAL INPUT:** 9-Pin D-type subminiature male connector for remote control of TEST, RESET, and REMOTE INTERLOCK DISABLE functions, as well as MEMORY SELECTION (See section 6.0. **Connection of Remote I/O** for more detailed information).
4. **REMOTE SIGNAL OUTPUT:** 9-Pin D-type subminiature female connector for monitoring PASS, FAIL, and PROCESSING output relay signals (See section 6.0. **Connection of Remote I/O** for more detailed information).
5. **SCANNER CONNECTOR:** For connection of optional external Scanner.
6. **REAR PANEL HIGH VOLTAGE OUTPUT TERMINAL:** 2nd high voltage output connector in parallel with the front panel connector.
7. **REAR PANEL RETURN OUTPUT TERMINAL:** 2nd return output connector in parallel with the front panel connector.

- 8. REAR PANEL CONTINUITY OUTPUT TERMINAL:** 2nd continuity output connector in parallel with the front panel output.
- 9. FUSE RECEPTACLE:** To change the fuse, unplug the power (mains) cord and turn the fuse receptacle counter-clockwise. The fuse compartment will be exposed. Please replace the fuse with one of the proper rating.
- 10. SCANNER OUTPUTS:** Optional internal Scanner matrix that provides 8 HV/Continuity/Return connections. Please refer to the Options section of this manual for additional connection information.
- 11. INPUT POWER RECEPTACLE:** Standard IEC 320 connector for connection to a standard NEMA style line power (mains) cord.
- 12. CHASSIS GROUND (EARTH) CONNECTION:** This terminal should be connected to a good earth ground before operation.

4. PROGRAMMING INSTRUCTIONS

4.1. Power Up

The HypotULTRA III automatically defaults to the Perform Tests screen upon power up. The Perform Tests screen will appear as follows:

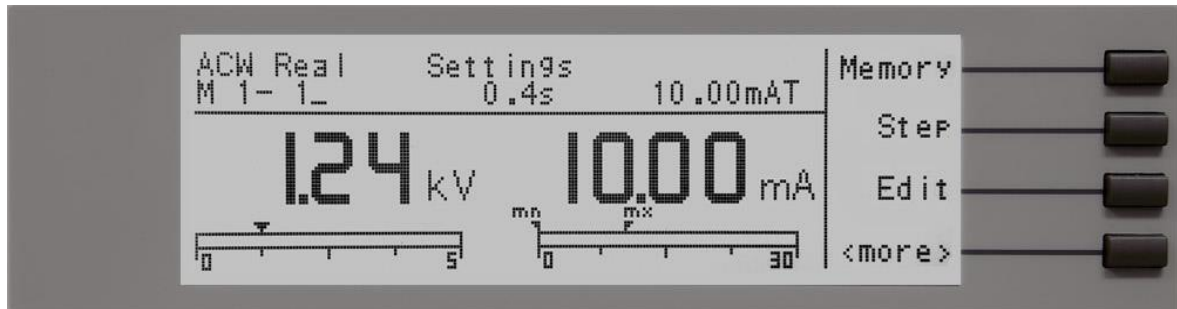

The Perform Tests screen is the main operational screen of instrument. From this screen all test parameters are monitored while the test is being performed. For more information refer to section **5.2. Perform Tests, Main Menu, and Results Screens**

4.1.1. Memory, Step, Connected Step Indicator, and Prompt Indicator

When in the Perform Tests screen, the HypotULTRA III will indicate the current memory location (M1-M50) and step number (1-30) in the upper-left part of the screen (i.e. M3-2).

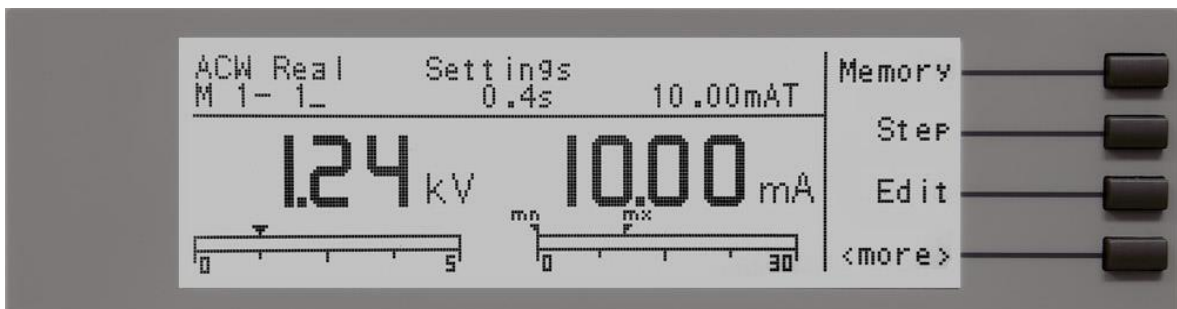

The connected step indicator is an underscore symbol located directly next to the memory and test step number (i.e. M4-2_) and only will be displayed when the Connect function for that step has been turned ON.

- **NOTE:** There are a total of 30 programmable steps per memory location. Step 30 of memory location 10 can be connected to step 1 of memory location 11 and so on.

The Prompt indicator is represented by the letter “P” located directly next to the connected step indicator (i.e. M50-8_P) and only will be displayed when the Prompt

feature for that step has been turned ON.

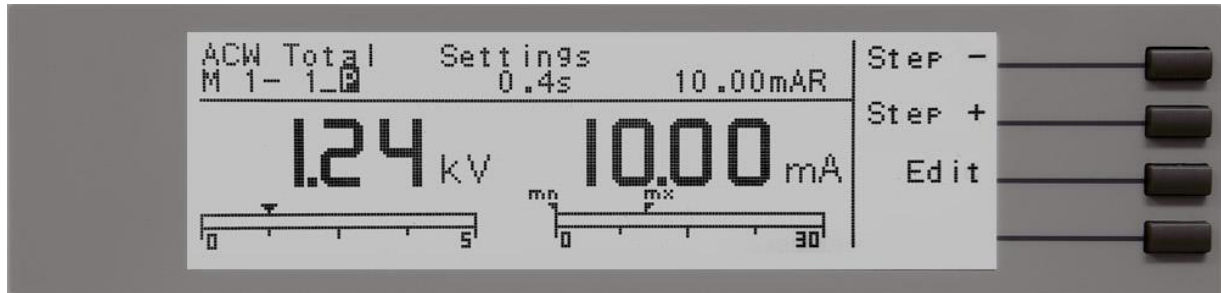

4.1.2. Analog Meters

A new feature unique to HypotULTRA III is analog bar graph meters. The bar graphs represent voltage and current and are located directly below their corresponding digital meter.

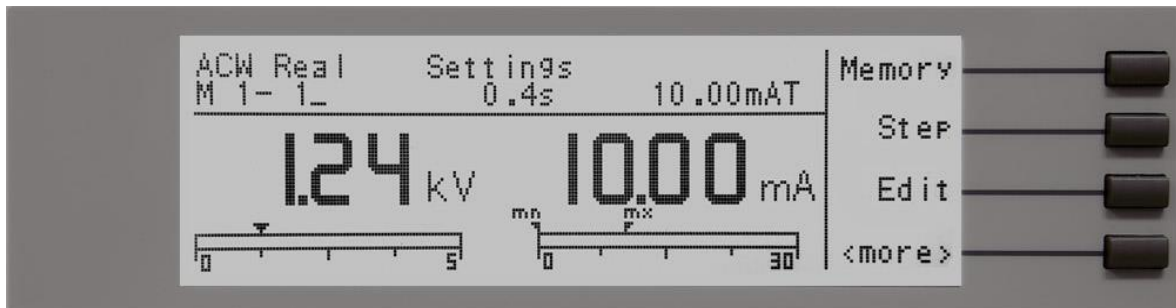

Along with the bar graph displays are arrows that point to the voltage setting in the case of the analog voltmeter and the Min Lmt and Max Lmt settings in the case of the current meter.

4.1.3. Perform Tests Screen Menu Selections

From the Perform Tests screen there are several software controls that may be accessed: Memory, Step, Edit, Results, and System. Pressing the <More> and <top> keys will cycle through these options.

Memory

The HypotULTRA III has 50, 30-step programmable memory locations (M1-M50). Press the "Memory" soft key to enter the Memory Recall screen. See section 4.3.1. **Selecting a Memory** for more information.

Step

The HypotULTRA III has 30 steps per memory location. Press the "Step" soft key to change or select a particular test step. See section 4.3.3. **Selecting a Step** for more information.

Edit

Press the "Edit" soft key to enter the Test Parameter Edit screen. For specific instructions for editing test parameters, refer to section 4.3. **Test Setup**.

Results

At the end of a test sequence or single step test, you may review the measurements of each test by pressing the <more> soft key and then pressing the “Results” soft key. The Results screen will appear as follow:

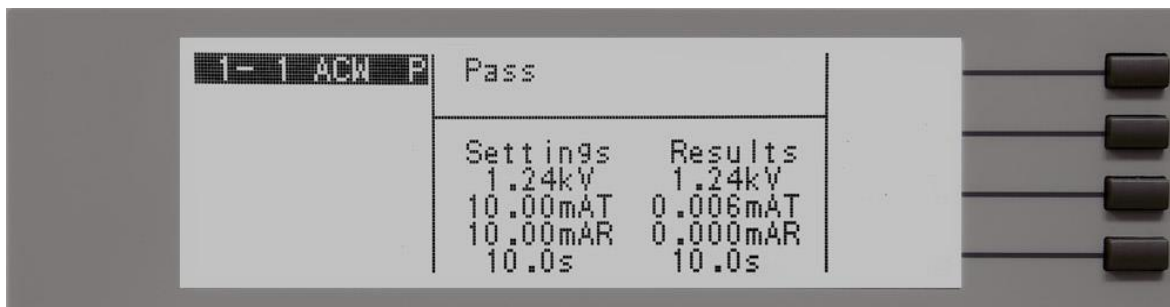

Using the “^, v” soft keys, scroll the highlighted area to the step results you wish to review. When the highlighted area is on the step you are reviewing, the test settings and results will appear on the right half of the display.

System

Pressing the “System” soft key from this menu will allow you to access the Setup System screen. For specific instructions for editing system parameters, refer to section 4.2. **System Setup**.

4.2. System Setup

1. From the Perform Test screen, press the <more> soft key. A second set of soft key selections will now be displayed.
2. From the secondary soft keys, press the “System” soft key. The Setup System parameters will now be displayed.
3. At the Setup System Menu you may scroll to all of the parameters by using the “^, v” soft keys.
4. If the printer card is installed, scrolling to <more> will display the second page of System Parameters that contain the printer functions.
5. From the Setup System screen, sixteen different Hardware and Software controls may be accessed; PLC Remote, Single Step, Fail Stop, Alarm, Contrast, Lock, Mem Lock, GPIB Address, Smart GFI, Results, Cal Alert, Cal Date, Cal Due, Alert, Date, and Time. Pressing the EXIT key at any time will return you to the Perform Test screen.

4.2.1 Setup System Keys

Directional soft keys <, >, ^, v

The “<, >, ^, v” soft keys are used to scroll the cursor to the different system parameters.

Edit

The “Edit” soft key is used to access the highlighted parameter and activates the Editing Menus.

An example of one of the editing menus is as follows:



If the selected parameter is a toggle selection, as shown in the example above, the bottom soft key will have the word “Change” next to it. After the “Change” soft key is pressed, the parameter will toggle and you will be prompted to press ENTER to save or EXIT to cancel the edit.

If the parameter is numeric, you may type in a new number using the numeric keypad. Once you begin typing a new number, the parameter will go blank and the cursor will begin blinking. This indicates that the parameter is being edited. Once a parameter is edited, it is necessary to complete the edit either by pressing the ENTER key to accept the new number or the EXIT key to cancel the edit and return to the original number.

Prev and Next

Once the Editing Menus are active, you may scroll through all of them by pressing the “Prev” and “Next” soft keys.

Change

The “Change” soft key is used to toggle parameters in the Edit Menus.

EXIT

The EXIT key is used to return to the Perform Tests screen from the Setup System Menu or will bring you back to the Setup System Menu from the Editing Menus.

4.2.2. System Parameters

Once the “Edit” soft key has been pressed from the System parameter listing you may scroll to and edit all of the parameters by pressing the “Prev” and “Next” soft keys.

Once a parameter is edited, it is necessary to complete the edit either by pressing the ENTER key to accept the change. Press the EXIT key to escape from the edit without altering the parameter.

PLC Remote

Highlight the PLC Remote parameter using the “<, >, ^, v” soft keys. When PLC Remote parameter is highlighted, press the “Edit” soft key.

The PLC Remote editing menu will now be displayed. You may turn the PLC remote function ON and OFF by pressing the “Change” soft key. Accept the change by pressing ENTER or cancel the edit by pressing EXIT.

When the PLC remote is turned ON, the front panel TEST button is disabled and a test may only be started through the rear panel I/O. If you attempt to start a test from the front panel TEST button when the PLC Remote function is turned “ON”, a pop-up message will be displayed. The pop-up message will appear as follows:



Refer to the section **6. Connection of Remote I/O** for details.

Single Step

Highlight the Single Step parameter using the “<, >, ^, v” soft keys. When the Single Step parameter is highlighted, press the “Edit” soft key.

The Single Step Editing Menu will now be displayed. You may turn the Single Step function ON and OFF by pressing the “Change” soft key. Accept the change by pressing ENTER or cancel the edit by pressing EXIT.

This function is used to temporarily override the automatic connection feature. When the Single Step function is ON the instrument will pause after each step is completed. To continue the test sequence, press the Test button to execute the next connected step. Each time the TEST button is pressed the next connected step will execute. If you press the RESET button before completing all connected steps, it will return you to the original starting step. If a step fails and you wish to continue to the next step, do not press RESET.

Fail Stop

Highlight the Fail Stop parameter using the “<, >, ^, v” soft keys. When the Fail Stop parameter is highlighted, press the “Edit” soft key.

The Fail Stop Editing Menu will now be displayed. You may turn the Fail Stop function ON and OFF by pressing the “Change” soft key. Accept the change by pressing

ENTER or cancel the edit by pressing EXIT.

Fail Stop is a function that will stop a sequence of tests at the step if a failure occurs. If this function is turned off, the sequence of tests will continue to the end of the sequence regardless of whether or not a failure has occurred. If the Fail Stop is OFF and a failure occurs during the test sequence, the RESET button will light and a short alarm will sound but the sequence will continue to the end. At the end of the test sequence the RESET button will light and alarm will sound indicating failure during the sequence. Pressing the RESET button will silence the alarm. Pressing the RESET button a second time will reset the instrument. Turn the Fail Stop function ON and OFF by pressing the “Change” soft key. Accept the change by pressing ENTER or cancel the edit by pressing EXIT.

Alarm Volume

Highlight the Alarm parameter using the “<, >, ^, v” soft keys. When the Alarm parameter is highlighted, press the “Edit” soft key.

The Alarm Volume Editing Menu will now be displayed. To change the volume of the alarm, type in a numeric value between 0 and 9. Press the ENTER key to accept the new number or the EXIT key to escape from the edit and return to the original number.

The numbers corresponding to the different volume settings are 0 through 9, 0 meaning the volume is off, and 9 being the loudest setting. After the number is entered, a momentary alarm chirp will occur to indicate the volume of the new setting.

LCD Contrast

Highlight the Contrast parameter using the “<, >, ^, v” soft keys. When the Contrast parameter cursor is highlighted, press the “Edit” soft key.

The Contrast Editing Menu will now be displayed. To change the Contrast of the display, type in a numeric value between 0 and 9. Press the ENTER key to accept the new number or the EXIT key to escape from the edit and return to the original number.

The numbers corresponding to the different contrast settings are 0 through 9, 0 meaning the lightest color of displayed characters and 9 meaning the darkest color of displayed characters. After the number is entered, the display will automatically adjust to the new display setting.

Results

Highlight the Results parameter using the “<, >, ^, v” soft keys. When the Results parameter is highlighted, you may use the “Change” soft key to select what type of results you would prefer are displayed at the end of a test or sequence of connected steps. The available selections are: All, P/F and Last. Press the ENTER key to accept the new setting or the EXIT key to cancel and return to the original setting.

When All is selected, a Results summary screen will be displayed at the end of the

test or sequence of connected steps displaying the results of all of the steps. The Results summary screen will appear as follows:

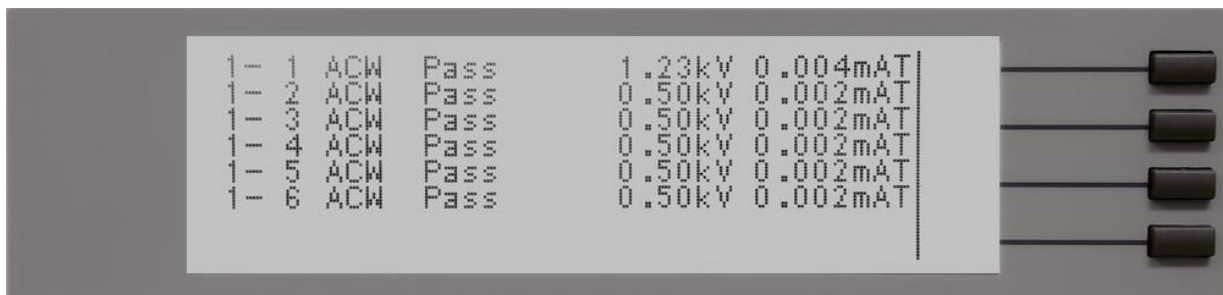

1-	1	ACW	Pass	1.23kV	0.004mAT
1-	2	ACW	Pass	0.50kV	0.002mAT
1-	3	ACW	Pass	0.50kV	0.002mAT
1-	4	ACW	Pass	0.50kV	0.002mAT
1-	5	ACW	Pass	0.50kV	0.002mAT
1-	6	ACW	Pass	0.50kV	0.002mAT

When P/F is selected, a Pass or Fail screen will be displayed at the end of the test. The Pass and Fail screens will appear as follows:



When P/F is selected, it is not possible to directly see the results of the test. In order to review the test results refer to section **4.1.3. Perform Tests Screen and Menu Selections.**

When Last is selected, the results of the last step performed will be displayed on the Perform Tests screen. There will not be a change in appearance or special screen displayed in this mode.

Security - Creating a Password

The main reason for the creation of a password is to prevent unauthorized access of Lock parameters in the system menu and unauthorized disabling of the Calibration Alert function. Once a password has been created both the lock functions and the Calibration Alert Screen disable will require the password to access.

Press and hold the top soft key while powering up the instrument, the Edit Password screen should now be displayed. The display will appear as follows:



You may now type in the new password using the numeric keypad, press the ENTER key to accept the new password or press the EXIT key to escape. After you type in your new password you will be required to confirm your new password by typing it again into the “Confirm Password” field. Press the ENTER key to confirm the new password or press the EXIT key to escape.

If the Password is set to 0, the Lock and Mem Lock parameters may be accessed by simply pressing the “Lock” and “Mem Lock” soft keys. If the password has been set to anything but 0, a password entry pop-up screen will appear to access the Lock and Mem Lock parameters. The Password default is preset to 0 at the factory.

Please refer to the Calibration Alert section of the manual for an explanation of how the password affects the Calibration Alert Disable.

Security - Forgotten Password

If you have forgotten your password, you may access all security functions by typing in the number “7600” into the password field. The old password cannot be recovered. A new password should be entered or enter “0” to disable the password.

Security - Secure Lock and Mem Lock Access

If a password has been created, when you press the “Lock” or “Mem Lock” soft keys, a password pop-up screen will appear. The pop-up message will appear as follows:



In order for you to access the Lock or Mem Lock parameters, you will now have to enter the proper password. If you have forgotten the password, please refer to the **Forgotten Password** instructions in the Security section.

Lock

Highlight the Lock parameter using the “<, >, ^, v” soft keys. When the Lock parameter is highlighted, you may turn the function ON and OFF by pressing the

“Change” soft key. Press the ENTER key to accept the new setting or the EXIT key to cancel and return to the original setting. When the ENTER key is pressed, the new security setting will take immediate effect. Selecting Lock ON restricts access to parameter and system settings. The level of security is determined by the Mem Lock function.

Mem Lock

Highlight the Mem Lock parameter using the “< , >, ^, v” soft keys. When the Mem Lock parameter is highlighted you may turn the function ON and OFF by pressing the “Change” soft key. Press the ENTER key to accept the new setting or the EXIT key to cancel and return to the original setting.

Mem Lock is a sub-function of the Lock setting. In order for the Mem Lock function to work, the Lock must first be turned ON. Selecting the Mem Lock OFF will allow the user to access all available memory locations and steps but restricts access to memory and step editing capabilities. Selecting the Mem Lock ON will allow the user to only run the currently loaded memory.

Smart GFI

The high voltage power supply of the HypotULTRA III is internally referenced to earth ground. Since the leakage current measuring circuit of the instrument monitors only current that flows through the return lead the possibility exists for current to flow directly from the high voltage output to earth ground without being measured. The SmartGFI (Ground Fault Interrupt) circuit monitors the current between the high voltage output and earth ground. Therefore, if the operator touches the high voltage lead and earth ground, the instrument will detect this hazardous condition and shut off immediately.

SmartGFI goes beyond a standard GFI circuit by automatically determining the return configuration of the DUT (grounded or floating) and enabling or disabling depending on the situation. When the HypotULTRA III's Return lead is floating, the SmartGFI circuit enables, protecting the test operator from electric shock. When the HypotULTRA III's Return lead is earth grounded, the SmartGFI circuit disables and the instrument operates in a grounded return mode of operation. If the GFI were to remain active in this state, the tester would continuously fail since all current is returning through earth ground. By disabling the SmartGFI circuit and operating in a grounded return mode, HypotULTRA III allows the user to perform tests on devices that have their chassis's earth grounded by the test fixture or test environment.

Cal Alert (Calibration Alert)

Calibration Alert is a feature that allows the instrument to give an advanced alert that the calibration for the instrument is coming due. Highlight the Cal Alert parameter using the “< , >, ^, v” soft keys. When the Cal Alert parameter is highlighted, you may turn the function ON and OFF by pressing the “Change” soft key. Press the ENTER key to accept the new setting or the EXIT key to cancel and return to the original setting.

Turning this parameter ON will activate the Cal Alert function and when the date matches the Alert Date, the instrument will display the Calibration Alert Warning screen upon power up. If the “Show this screen again?” function has been turned OFF at the Calibration Alert Warning screen, this parameter will automatically be set to OFF.

Cal Date (Calibration Date)

Calibration Date is a non-editable parameter that indicates the date when calibration was last performed on the instrument. This parameter automatically updates after calibrating the instrument.

Cal Due (Calibration Due Date)

It is recommended that calibration should be performed at least once a year. It is recommended that the Calibration Due Date not be set greater than one year from the Calibration Date displayed. After a calibration is performed, the Calibration Due Date is automatically set 1 year after the calibration date.

This parameter defaults to one year after the calibration date but may be overwritten to any advanced date desired. Within the Calibration Due Date parameter are three separate fields: month, day, and year. Use the “<” and “>” soft keys to select the field within the date you want to edit. Use the numeric keypad to change the values in the Date fields and press ENTER to accept the new number or press EXIT to cancel and return to the original number.

Alert (Alert Date)

The Alert Date is like an alarm clock that will warn you in advance of the actual Calibration Due Date. After a calibration is performed, the Alert Date is automatically set 11 months after the Calibration Date. For example, if the calibration is performed on 12/15/2003 the Alert Date will automatically be set to 11/15/2004.

This parameter defaults to 11 months after the Calibration Date but may be overwritten to any advanced date desired. Within the Alert Date parameter are three separate fields: month, day, and year. Use the “<” and “>” soft keys to select the field within the date you want to edit. Use the numeric keypad to change the values in the date fields and press ENTER to accept the new number or press EXIT to cancel and return to the original number.

Date

Highlight the Date parameter using the “< , > , ^, v ” soft keys.

Within the Set Date parameter are four fields, date format (mdy / dmy), month, day, and year. Use the “<” and “>” soft keys to select the field within the date you want to edit. Use the “Change” soft key for toggling the date format parameter or use the numeric keypad to change the values in the date fields. Press ENTER to accept the new number or press EXIT to cancel and return to the original number.

Time

Scroll the cursor to the Time parameter using the “<, >, ^, v” soft keys.

Within the Set Time parameter are three fields: hours, minutes, and Military or Standard time setting. Use the “<” and “>” soft keys to select the field within the date you want to edit. Use the numeric keypad to change the values in the date fields and press ENTER to accept the new number or press EXIT to cancel and return to the original number.

Calibration Alert Screen

The Calibration Alert Warning screen appears with all security settings set to OFF appears as follows:

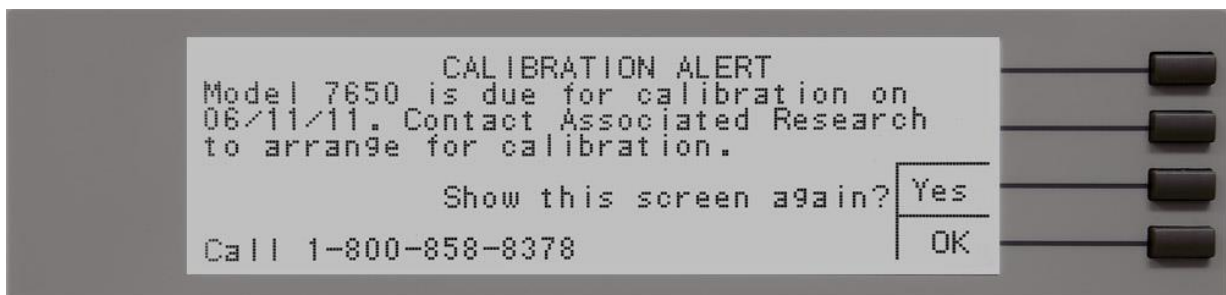

The Calibration Alert Warning screen appears with all security settings set to ON and password enabled appears as follows:



At the Cal-Alert Warning screen “Show screen again?” will be displayed along with the options “Yes” or “No.” The question must be answered by toggling between the words “Yes” and “No” using the corresponding soft key and then pressing the “OK” soft key. Selecting the “Show this screen again” parameter “No” will disable the Cal-Alert function. Selecting the “Show this screen again” parameter “Yes” will exit the Cal-Alert Warning screen and go to the standard introduction screen without disabling the Cal-Alert function.

If security is enabled without a password (password set to 0) you will not see the question “Show screen again” or the “Yes/No” soft key. The only option available is to press the “OK” soft key. This guarantees that while the security is enabled that the Calibration Alert once tripped cannot be disabled without going to the System Menu

and turning it OFF.

If the security is enabled with a password, the Password pop-up screen will appear over the Calibration Alert screen. While in this state the instrument will be virtually unusable until the password is entered. Once the password is entered, the security at the Calibration Alert screen will be bypassed and the “Show screen again? Yes or No” options will be available as described previously.

4.2.3. Default System Parameters

HypotULTRA III comes from the factory with the following system presets:

SYSTEM PARAMETERS		
Setup	PLC Remote	OFF
	Single Step	OFF
	Fail Stop	ON
	Alarm	5
	Contrast	5
	Results	Last
	Lock	OFF
	Mem Lock	ON
	Address (GPIB only)	8
	Smart GFI	ON
	Results	Last
	Cal Alert	ON
Security	Password from Factory	0
	Security based on Password	OFF

4.2.4. Memory, Step, and Default System Parameter Initialization

WARNING Initializing the instrument will overwrite all memories and steps with ACW default parameters!

Press the 0 and 1 numeric keys and power the instrument at the same time, then press the “Yes” soft key. All memories and steps will be loaded with the ACW default parameters and the System parameters will be set to the factory defaults. The default system parameters are as follows:

Setup	PLC Remote	OFF
	Single Step	OFF
	Fail Stop	ON
	Alarm	5
	Contrast	5
	Results	Last
	Lock	OFF
	Mem Lock	ON
	Address (GPIB only)	8

Smart GFI	ON
Results	Last
Cal Alert	ON
Date	mdy

The following System parameters will not be affected by the system initialization:

Setup	Cal Date	No change
	Cal Due	No change
	Alert	No change
	Date	No chnage
	Time	No change
Security	Password	No change
	Security	No change

4.3. Test Setup

4.3.1. Selecting a Memory Location

From the Perform Tests screen, press the “Memory” soft key. The Memory Recall screen will now be displayed.

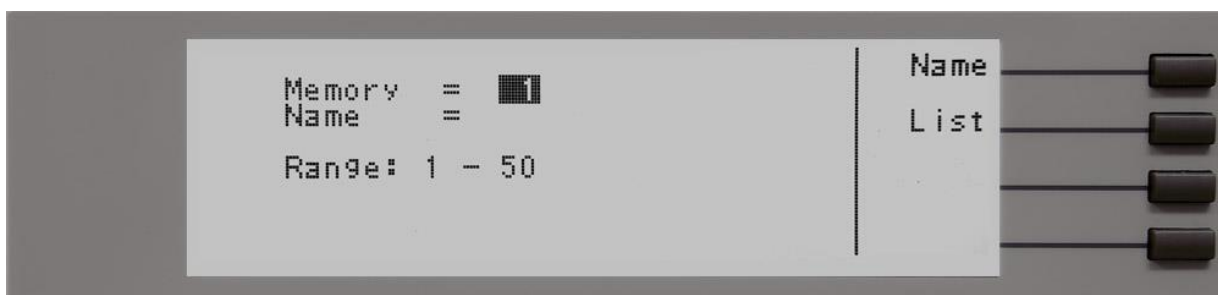

Two methods may be used to select a memory location.

1. Type in the number of the memory location that you would like to use. As with all of the parameters, once you begin typing a new number the parameter will go blank and the cursor will begin blinking. This indicates that the parameter is being edited. Once a parameter is edited, it is necessary to complete the edit either by pressing the ENTER key to accept the new number or the EXIT key to escape from the edit and return to the original number.
2. Press the “List” soft key and scroll the highlighted area to the desired memory location, then press the ENTER key. An example of the list display is as follows:



Once you press the ENTER key, the memory location and all of its steps will be loaded into the instruments active memory for use. Once the memory location is loaded, the Perform Test screen will once again be displayed.

4.3.2. Naming a Memory Location

At the Memory Recall screen, press the “Name” soft key. The character map screen will now be displayed.

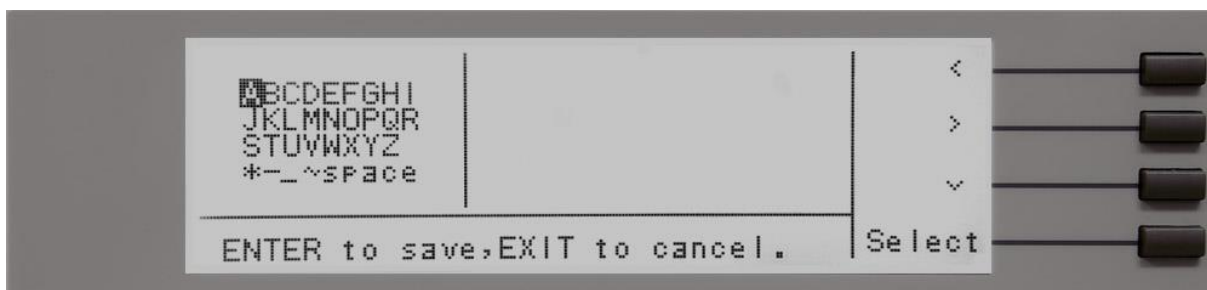

Use the “<, >, ^, v” soft keys to navigate through the character map and use the bottom soft key to select a character. The backspace key may be used to delete the last character. Press ENTER to save or EXIT to cancel changes. The memory name can be no more than 10 characters in length.

4.3.3. Selecting a Step

From the Perform Tests screen, press the “Step” soft key. The soft keys will now change to “Step -”, “Step +”, and “Edit”. The display will appear as follows:

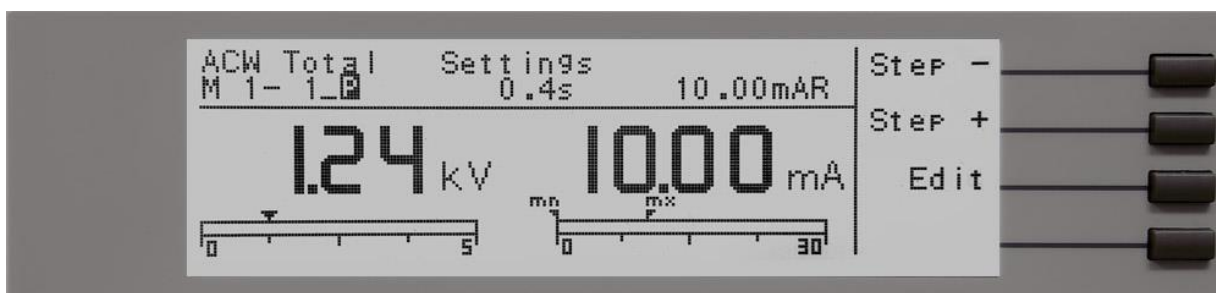

You may now select a step by using the “+” and “-” soft keys. Once you have located the desired step, you may access the step’s parameters by pressing the “Edit” soft key.

4.3.4. Test Parameters

Test Parameter Notes

- Once you begin typing a new number, the parameter will go blank and the cursor will begin blinking. This indicates that the parameter is being edited. Once a parameter is edited, it is necessary to complete the edit either by pressing the ENTER key to accept the new number or the EXIT key to escape from the edit and return to the original number. The one exception to this rule is the Scanner parameter. The Scanner parameter will not go blank when being edited.
- When the ENTER key is pressed to accept a parameter change, the instrument will automatically advance to the next Test Parameter Edit screen.
- The Test Parameter Edit screen displays the Range of the parameter that is highlighted. Use this as a guide when setting your parameters.
- The “Change” soft key in the Parameter Menu selects different conditions and no data entry is required, i.e. the “Change” soft key in the AC Withstand toggles between 50Hz and 60Hz. It is necessary to press the ENTER key to accept the new parameter or press EXIT to cancel the edit.
- Selecting the test type (ACW, DCW and IR) automatically loads the default parameters for that particular type of test. Refer to section **4.3.5. Default Test Parameters** for the preset default parameters.
- Scanner and External scanner parameters will only appear in the Parameter screens if the options are installed.

Voltage: The voltage that is applied to the high voltage and return terminals during a test.

Max Lmt: The maximum current or resistance threshold that triggers a failure when exceeded.

Min Lmt: The minimum current or resistance threshold that triggers a failure when not exceeded.

Ramp Up: The length of time that is allowed for the test voltage to climb from 0 to the programmed test voltage.

Dwell: The length of time that is allowed for the programmed test voltage to be applied.

Delay: The length of time that the programmed test voltage is applied but no judgment of the set parameters is made. Judgment of the parameters is not made until the end of the delay time.

Ramp Dn: The length of time that is allowed for the test voltage to decay from programmed test voltage to 0.

DID YOU KNOW?

Associated Research, Inc provides detailed whitepapers and articles on our website. Check out the following link for more information on Arc Sensitivity:

<http://www.asresearch.com/events-training/white-papers.aspx>

Arc Sense: The maximum allowable threshold for arcing. The numbers 0 through 9 correspond to the different arc sensitivity levels, 1 meaning the maximum threshold of allowable arcing, 9 meaning the minimum threshold of allowable arcing, and 0 being OFF. After the “+” or “-” soft keys are pressed, the arc sensitivity will automatically adjust to the new setting. Arc detection is not required for testing.

Frequency: This parameter is available in AC testing only and may be toggled between 50 and 60 Hz.

Continuity: This function checks for a connection between the Cont. Check and Return lead. This is a basic DC continuity check that measures the continuity value but does not display it. Continuity may be turned ON or OFF.

Offset: Used during the Continuity test to factor out test lead and fixturing resistance.

Connect: This function will connect or link the current test step to the next test step. Step 30 of memory locations 1 through 49 may be connected to step 1 of the subsequent memory location (i.e. M29-30_ will connect to M30-1).

Scanner or EX Scanner: (This parameter will only be seen on units equipped with a scanner). This parameter allows for setup of multiple Scanner channels. The three different selectable Scanner states are L (scanner channel set to the return point), H (scanner set to the high voltage point) and O (OFF).

Prompt

The Prompt function allows you to insert a short line of text in a step. The Prompt will appear on the screen before the step is initiated and remains on the screen until the TEST button is pressed. After the TEST button is pressed, the Prompt will clear and the step will initialize.

At the Perform Test screen, use the “Memory” and “Step” soft key functions to select the desired test step that you would like the Prompt to appear before. At the Perform Test screen, press the “Edit” soft key. Scroll the highlighted area to the “Prompt” parameter and press ENTER. The character map screen will now be displayed. The character map will appear as follows:

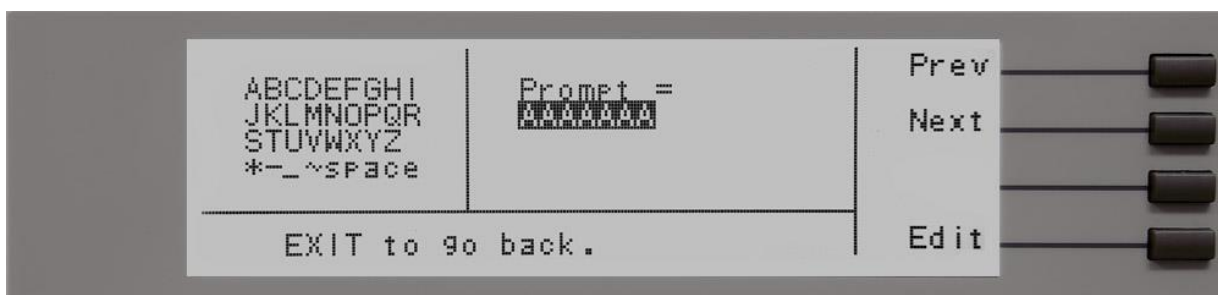

This screen will only show when scrolling one parameter at a time through the parameter list with “Prev” and “Next” soft keys. Press the “Edit” soft key to edit or

insert a Prompt.

To enter a text prompt, use the arrow keys to scroll the highlighted area to the character (or enter a number from the numeric keypad) you wish to use and then press the “Select” soft key. The letter or symbol will be inserted at the point where the cursor is flashing. The cursor will then increment to the next position and wait for an additional character insertion. If you make a mistake or want to change the character, press the “←” key in the numeric keypad. The cursor will decrement and erase the character. When you have finished editing the prompt press the ENTER key. After a Prompt is inserted in a step, a “P” will appear within the step parameters below the step number.

4.3.5. Default Test Parameters

Each of the test types (AC Withstand, DC Withstand and IR) have specific default test parameters that automatically load when test type is selected from the Parameter Edit screen. The following table is a listing of the Default Parameters for each of the different types of tests that are available in the HypotULTRA III. The Default Parameters are as follows:

TEST TYPE	PARAMETER	VALUE
ACW	Voltage	1240V
	Max Lmt T	10.00mA
	Min Lmt T	0.000mA
	Max Lmt R	10.00mA
	Min Lmt R	0.000mA
	Display	Total
	Ramp UP	0.1s
	Dwell	1.0s
	Ramp DN	0.0s
	Connect	OFF
	Frequency	60Hz
	Arc Detect	OFF
	Arc Sense	5
	Continuity	OFF
	Scanner	00000000
DCW (7650 only)	Voltage	1500V
	Max Lmt	10000uA
	Min Lmt	0.0uA
	Ramp UP	0.1s
	Dwell Time	1.0s
	Ramp DN	0.0s
	Connect	OFF
	Ramp-HI	OFF
	Charge-LO	0.0uA
	Arc Detect	OFF

TEST TYPE	PARAMETER	VALUE
	Arc Sense	5
	Continuity	OFF
	Scanner	00000000
	Prompt	
IR (7650 only)	Voltage	500V
	Max Lmt	0.00M Ω
	Min Lmt	0.05M Ω
	Ramp UP	0.1s
	Delay	1.0s
	Ramp DN	0.0s
	Connect	OFF
	Charge-LO	0.000uA
	Scanner	00000000
	Prompt	
CONT	Max-Lmt	10.00 Ω
	Min-Lmt	0.00 Ω
	Dwell	1.0s
	Offset	0.00 Ω
	Connect	OFF
	Scanner	00000000

4.3.6. Setting Up a Test

From the Test Parameter edit screen, you may set your own custom set of parameters for the test or choose the ACW, DCW, IR, and Continuity defaults. All of the individual parameters for the test may be accessed using the “Prev” and “Next” soft keys. As the “Prev” and “Next” soft keys are pressed, the screen will change for the different parameters. The ENTER key may also be used to scroll to the different parameters. For a detailed explanation of the Scanner parameter and how this feature works, refer to the **Section 9. Options**.

1. From the Test Parameter Review screen (refer to **Section 4.2.4. Test Parameters**), scroll the highlighted area to the test parameter you wish to edit using the “< , >, ^, v” soft keys.
2. Press the “Edit” soft key. The Test Parameter Edit screen will now be displayed.
3. To change numeric parameters, simply type the new number in using the numeric keys.
4. Once you begin typing a new number, the parameter will go blank and the cursor will begin blinking. This indicates that the parameter is being edited. Once a parameter is edited, it is necessary to complete the edit either by pressing the ENTER key to accept the new number or the EXIT key to cancel the edit and return to the original number. The one exception to this rule is the scanner parameter. The scanner parameter will not go blank when being edited. To change toggle parameters, simply press the “Change” soft key. Once a parameter is edited, it is necessary to complete the edit either by pressing the ENTER key to accept the new setting or the EXIT key to cancel

the edit and return to the original number.

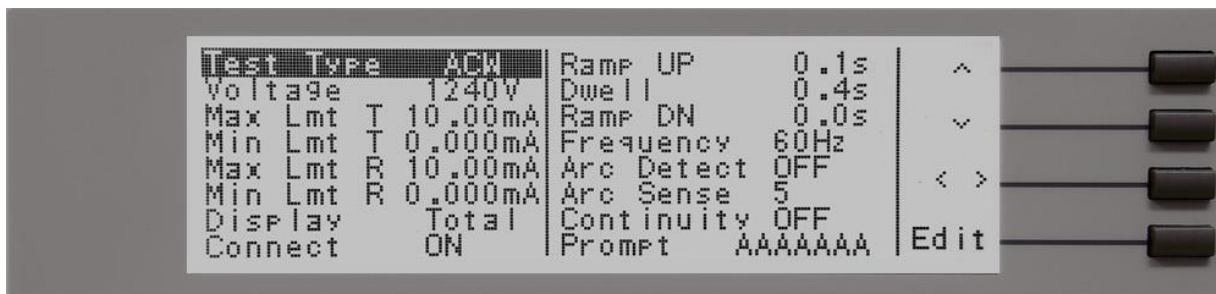

When you are done modifying test parameters, press the EXIT key twice to return to the Perform Test screen.

The instrument is now ready to perform tests with the modified parameters.

AC Withstand

From the Test Parameter Review screen, scroll the highlighted area to the Test Type and press the “Edit” soft key.

The Test Parameter Edit screen will now be displayed. Now press the “Change” soft key until the letters ACW appear in the parameter field. Press the ENTER key to select the ACW test. The AC Withstand Parameter Review screen will appear as follows:

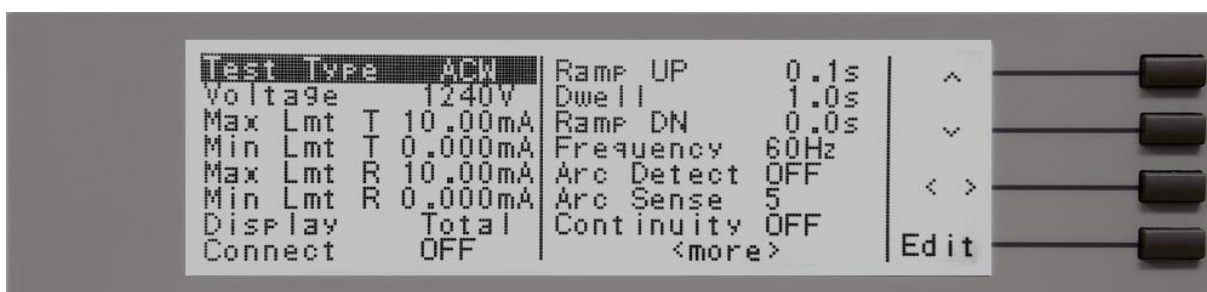

The second or <more> screen will only appear if there is a scanner selection in the menu. The Scanner selections will only appear if there is a scanner installed or an external Scanner connected to the instrument (this is an auto-detect feature in hardware).

From the AC Withstand Setting screen the following parameters may be selected for editing: Voltage, Max-Lmt T, Min-Lmt T, Max-Lmt R, Min-Lmt R, Display Total/Real, Connect, Ramp Up, Dwell Time, Ramp Down, Frequency, Arc Detect (ON/OFF), Arc Sense, Continuity selection (DC continuity or OFF), Prompt and Scanner Channel selections (if there is a scanner installed).

Real Current

The AC Real Current function allows the user to monitor only the real portion of the leakage current and ignore any reactive components due to capacitance in the device under test. It is important to recognize that the total current is the vector sum of the reactive and real current, not the direct addition of the two components. As in a right triangle, the total current is the square root of the sum of the squares of the real and reactive currents.

Since the real component is usually much smaller than the reactive current, a doubling of the real current increases the total current by only a small amount. Unless the two components are separated, a doubling of the real leakage current can go virtually undetected by a total current measurement.

Because Real Current is installed in HypotULTRA III, additional parameter selections are added to the ACW test parameters. The additional test parameters are Max Lmt R (Real Current Maximum limit), Min Lmt R(Real Current Minimum Limit) and Display. The standard total current limits have a “T” next to them indicating total current.

The AC Real Current function allows the operator to view both real and total current simultaneously. The Display parameter allows you to select which meter will display the real and total current. When the display parameter is set for Total, the large current meter will display the total current and the real current will be displayed in the small current meter below the memory location name. The opposite is true when the display parameter is set for Real.

DC Withstand (Model 7650 only)

From the Test Parameter Review screen, scroll the highlighted area to the Test Type and press the “Edit” soft key.

The Test Parameter Edit screen will now be displayed. Now press the “Change” soft key until the letters DCW appear in the parameter field. Press the ENTER key to select the DCW test. The DC Withstand Parameter Review screen will appear as follows:

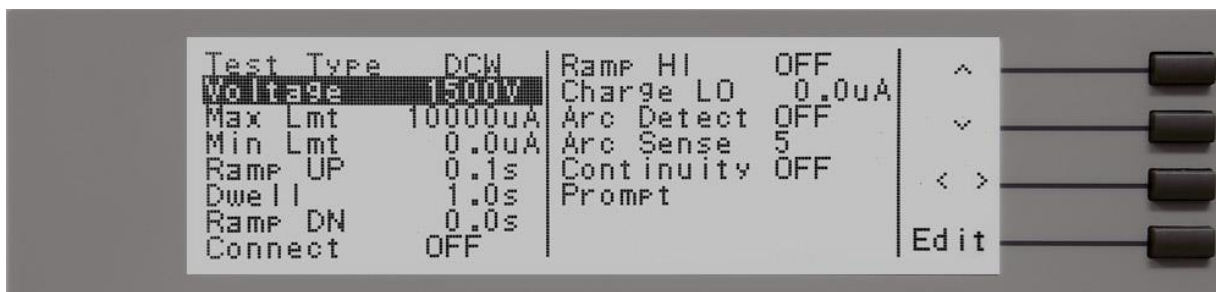

The Scanner selections will only appear if there is a scanner installed or an external Scanner connected to the instrument (this is an auto-detect feature in hardware).

From the DC Withstand Parameter Review screen the following parameters may be selected for editing: Voltage, Max-Lmt, Min-Lmt, Ramp Up, Dwell Time, Ramp Down, Connect, Ramp-HI, Charge LO, Arc Detect (ON/OFF), Arc Sense, Continuity selection (DC continuity or OFF), Scanner Channel selections if installed, and Prompt.

Ramp-HI

The Ramp-HI function is active during the Ramp period only. Ramp-HI will allow current higher than the normal Max-Lmt current setting of the DC Withstand Voltage test to avoid false failure due to charging current.

Charge-LO

The Charge-LO function is used to check if the cables are connected properly at the beginning of a test. A capacitive DUT will draw charging current on the DC Withstand test when the Output is activated. If the charging current is lower than the setting, the test cables may not be connected properly. The instrument can set the Charge-LO parameter manually or automatically. To manually set the Charge-LO current, use the “^ ,v” soft keys or the ENTER key and scroll the highlighted area to the Charge-LO current parameter. Enter the new Charge-LO current via the numeric keypad and then press the ENTER key to accept the new parameter or press the EXIT key to escape from the edit. To automatically set the Charge-LO current, use the “^ , v” soft keys or the ENTER key and scroll the highlighted area to the Charge-LO current parameter. Set the voltage and ramp times to the values that will be used on the DUT and connect the test cables or test fixture between the instrument and DUT. Press the TEST button.

WARNING

Please be aware that the program will activate high voltage on the output connector while the TEST button is pressed.

The program will read the charging current of the DUT and set the Charge-LO current at approximately one half (1/2) of the reading. The instrument will beep and the new value will automatically be updated in the field. You do not need to press the ENTER key for the new parameter to be accepted.

Insulation Resistance (Model 7650 only)

From the Test Parameter Review screen, scroll the highlighted area to the Test Type and press the “Edit” soft key.

The Test Parameter Edit screen will now be displayed. Now press the “Change” soft key until the letters IR appear in the parameter field. Press the ENTER key to select the IR test. The IR Parameter Review screen will appear as follows:

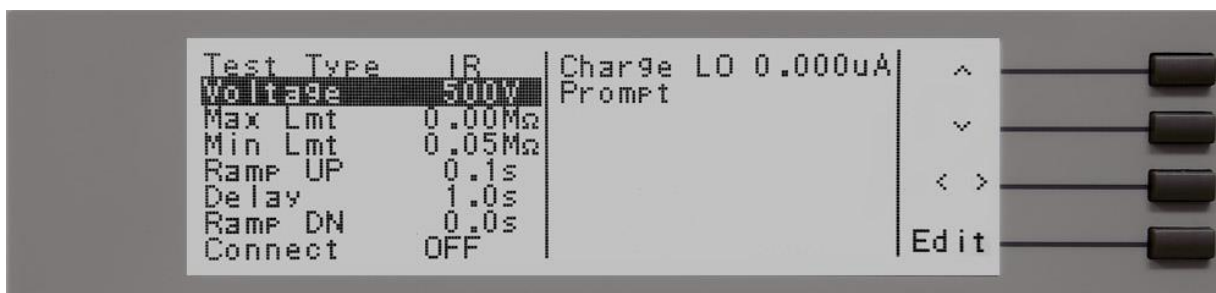

The Scanner selections will only appear if there is a Scanner installed or an external Scanner connected to the instrument (this is an auto detect feature in hardware).

From the Insulation Resistance Parameter Review screen, the following parameters may be selected for editing: Voltage, Max-Lmt, Min-Lmt, Ramp Up, Delay Time, Ramp Down, Connect, Charge-LO, Scanner Channel Output Select (if installed) and Prompt.

Continuity

The Continuity test is generally used to test the ground conductor of a line cord. If the resistance exceeds Max-Lmt trip point or drops below the Min-Lmt trip point the HypotULTRA III will signal a continuity failure. If you are testing products with two prong plugs, do not activate the continuity circuit.

From the Test Parameter Review screen, scroll the highlighted area to the Test Type and press the “Edit” soft key.

The Test Parameter Edit screen will now be displayed. Now press the “Change” soft key until the letters CONT appear in the parameter field. Press the ENTER key to select the CONT test. The CONT Parameter Review Screen will appear as follows:

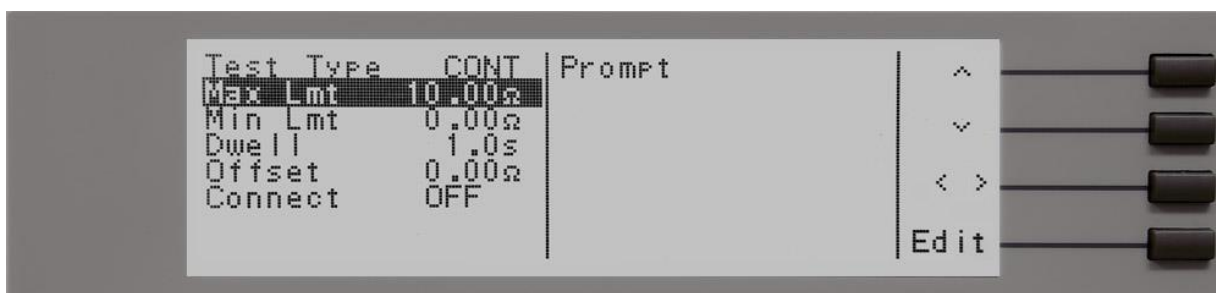

The Scanner selections will only appear if there is a Scanner installed or an external Scanner connected to the instrument (this is an auto-detect feature in hardware).

From the Continuity Parameter Setting screen, the following parameters may be controlled: Max-Lmt, Min-Lmt, Dwell, Offset, Connect, Scanner Channel Output Select if installed, and Prompt.

Offset

This function allows the instrument to compensate for lead and test fixture resistance during a Continuity test. Using the “^ , v” soft keys or the ENTER key, scroll the highlighted area to the Offset parameter. You may now manually or automatically set the Offset value.

To manually set an Offset value enter a $m\Omega$ value via the numeric keypad and then press the ENTER key to accept the new value or press the EXIT key to escape from the edit.

To automatically set an Offset value, set the output voltage, current, and frequency to the values that will be used on the DUT and connect the test cables, test fixture, or Scanner channel with fixturing to the instrument. Next, short the ends of the test cables and press the TEST button. The instrument will beep and the new value will automatically be updated in the field. You do not need to press the ENTER key for the new parameter to be accepted.

- **NOTE:** do not connect the DUT to the instrument when performing an offset. This will create erroneous results when a test is performed.

5. OPERATING INSTRUCTIONS

5.1. Instrument Connections

The test leads and the adaptor box may be connected to the receptacle located on the front or back of HypotULTRA III. These receptacles are wired in parallel and may be used depending upon the application

5.1.1. Connecting the Test Leads

The instrument comes with all cables necessary for performing a Hipot and Continuity test. Plug the red alligator clip into the HV receptacle on the HypotULTRA III. Connect one of two black alligator clip leads to the Return receptacle and the other to the Cont. Check receptacle.

5.1.2. Connecting the Adaptor Box

The adapter box provides an easy way to connect a line cord-terminated DUT to the HypotULTRA III. The following diagram shows how to connect the adapter box to the HypotULTRA III and to the DUT.

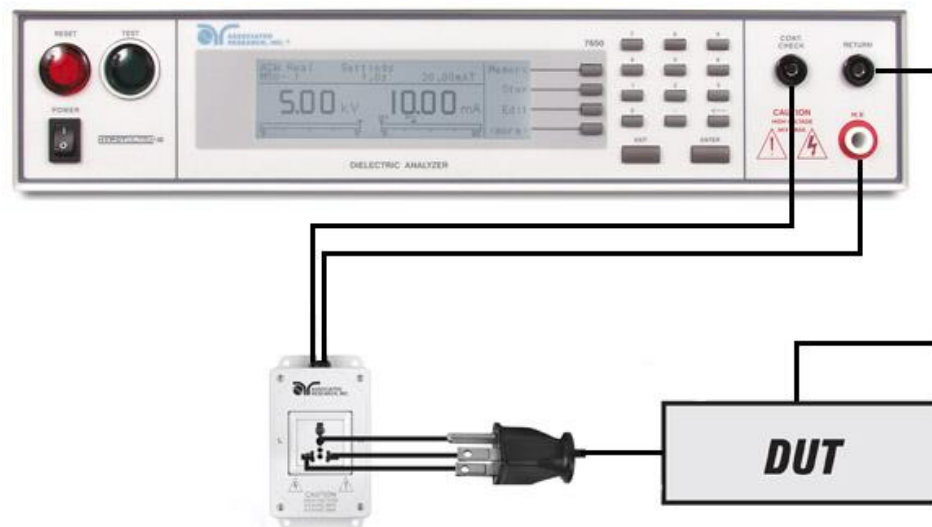

5.1.3. Interlock Connector

HypotULTRA III is equipped with a Remote Interlock feature. Remote Interlock utilizes a set of closed contacts to enable the instrument's output. If the Remote Interlock contacts are open the output of the instrument will be disabled. Remote Interlock can also be referred to as a remote system lockout, utilizing "fail when open" logic. To disable the Remote Interlock feature connect the Interlock Key into the Signal Input

port located on the back of the tester.

5.2. Performing a Test

1. As instructed in section **4.2. System Setup**, select a memory and step that is suitable for the test you would like to perform.
2. Attach the appropriate DUT to the instrument (refer to section **5.1. Instrument Connections**).
3. Press the TEST button.
4. The instrument will now perform the test or connected sequence of tests.

● **NOTE:** If the test is started from a step other than 01, it will always return to the originally selected step when you push RESET or TEST buttons.

5. If a Prompt is embedded within a step, the test will pause at that step and display the Prompt as a pop-up message. An example of a prompt will appear as follows:

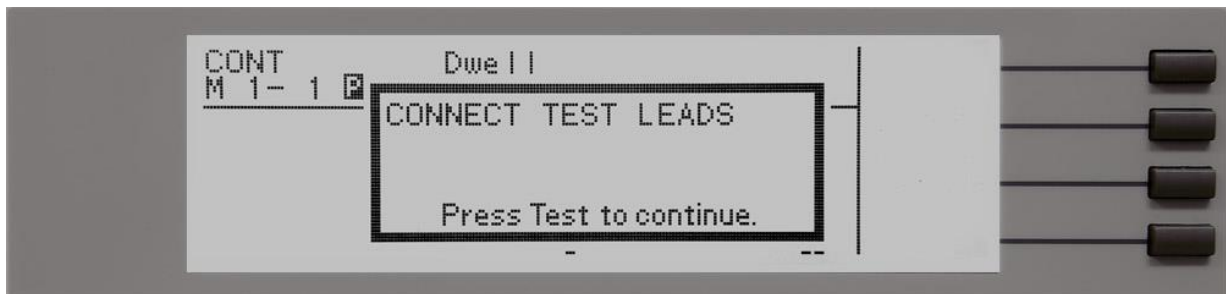

6. In order to clear the Prompt and continue the test, push the TEST button.
7. During a test, the appropriate metering will be displayed for the type of test that is being performed (Refer to section **5.3. Perform Tests Metering**). At the end of the test sequence, the top field of the display will indicate PASS if all the tests have completed successfully or indicate FAIL if any of the tests did not complete successfully.

Manual Voltage Adjustment

The test voltage may be adjusted up and down during a test by pressing the “+” and “-” soft keys.

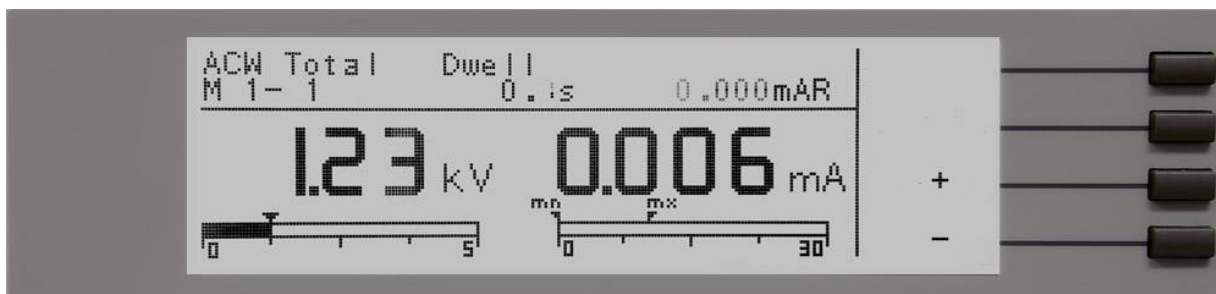

When the Lock parameter is selected ON in the System Menu, manual voltage adjustment is disabled. Therefore, you will not see the “+” and “-” soft keys.

5.3. Perform Tests Metering

Each test performed by the HypotULTRA III contains a unique set of parameters and therefore requires specialized metering for each test. The following table describes what meters will be displayed for each of the different test types:

TEST TYPE	REAL CURRENT	TOTAL CURRENT	VOLTAGE	TIME	RESISTANCE
AC Withstand	X	X	X	X	NA
DC Withstand	NA	X	X	X	NA
IR	NA	NA	X	X	X
Continuity	NA	NA	NA	X	X

Real Current Display

The AC Real Current function allows the operator to view both real and total current simultaneously. The Display parameter (refer to section 4.3.6. **Setting Up a Test**) allows you to select which meter will display the real and total current. When the Display parameter is set for Total, the large current meter will display the total current and the real current will be displayed in the small current meter below the memory location name. The opposite is true when the display parameter is set for Real.

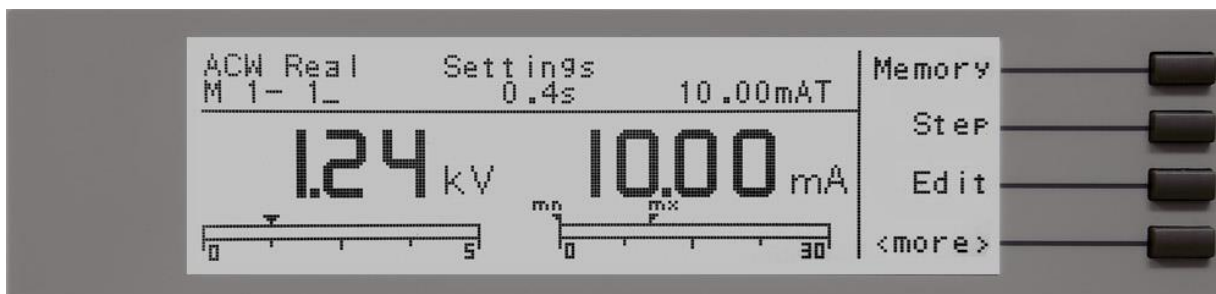

5.4. Results Screens

The HypotULTRA III may be configured to display one of three different types of Results screens (see section 4.2. **Setup System** for more information). To access the results screen use one of the following methods:

Method 1, Hot key

Pressing the bottom soft key at the Perform Tests screen will display the Results screen.

Method 2, Menu Selection

1. From the Perform Tests screen, press the “Menu” soft key. The Main Menu will now be displayed.
2. From the Main Menu screen, press the “Menu” soft key. The Results, Test and System selections will now be displayed.
3. From this screen, press the “Result” soft key. The Results screen will now be displayed. The Results screen will appear as follows:

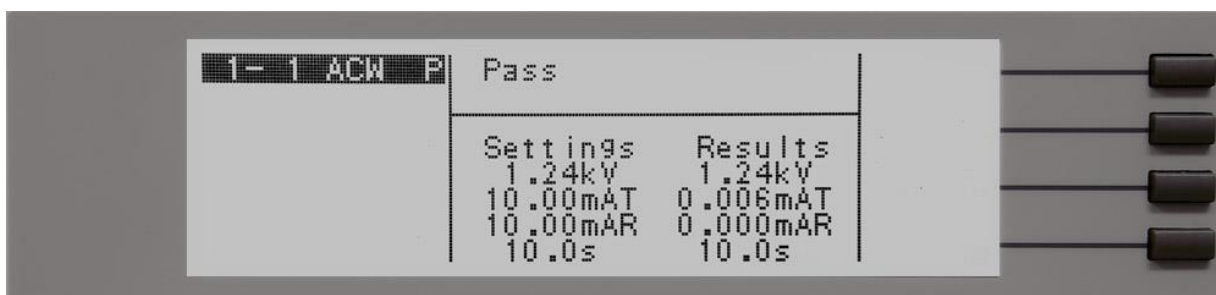

- **NOTE:** For connected tests, use the “^” and “v” soft keys to scroll through the results.

5.5. Error Messages

Directly above the metering screens is the test status display. This portion of the display is active during the test and allows you to view the type of test being performed and status of the test step. At the end of a test, the test status display will inform you either that the test has passed or failed. The following is an example of the test status display:

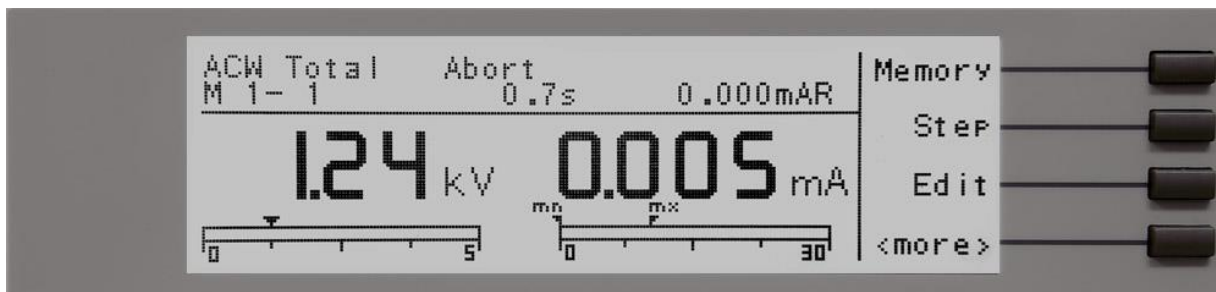

If there is an error during testing, the error description will be displayed on the screen. Below is a list of error messages that the HypotULTRA III reports:

Abort: This message appears on the display if the test in process is aborted with the RESET button or remote Reset control.

Max-Lmt: This message appears on the display if the DUT measurement exceeds the Max-Lmt setting of any parameter.

Min-Lmt: This message appears on the display if the DUT measurement drops below the Min-Lmt.

CONT-Fail: This message appears on the display if the DUT fails the basic continuity check performed during an AC/DC Withstand test (if Continuity is selected “ON”).

Arc-Fail: This message appears on the display if the DUT arcing current exceeds the Arc Sense limit and Arc function is active (Arc Sense = 1...9) of the AC/DC Withstand test.

Short: This message appears on the display if the DUT current is well beyond the metering range of the test.

Charge-LO: This message appears on the display if the leakage current during Ramp-up falls below the Charge -LO setting.

Breakdown: This message appears on the display if the DUT current is well beyond the metering range of the test and the arcing condition beyond the arc sense limit.

GND-Fault: This message appears on the display if the GFI threshold is exceeded during the test.

Interlock Open: This message appears on the display if the Remote Interlock feature is activated before or during a test. The Remote Interlock feature utilizes a set of closed contacts which will disable the instrument’s output if they are opened before or during a test. Remote Interlock could also be referred to as a remote system lockout, utilizing “fail when open” logic. The Remote Interlock feature may be disabled by plugging the “Interlock Disable Key” provided into the Signal Input connector. See section **6.2. Remote Signal Inputs and Memory Access** for more information.

Output Error: This message appears on the display, if the instrument's output reading does not match the setting. This message will only be seen if the EXIT key is pressed at the Output Error screen. If the instrument has an output problem when the TEST button is pressed, the Output Error screen will appear as follows:

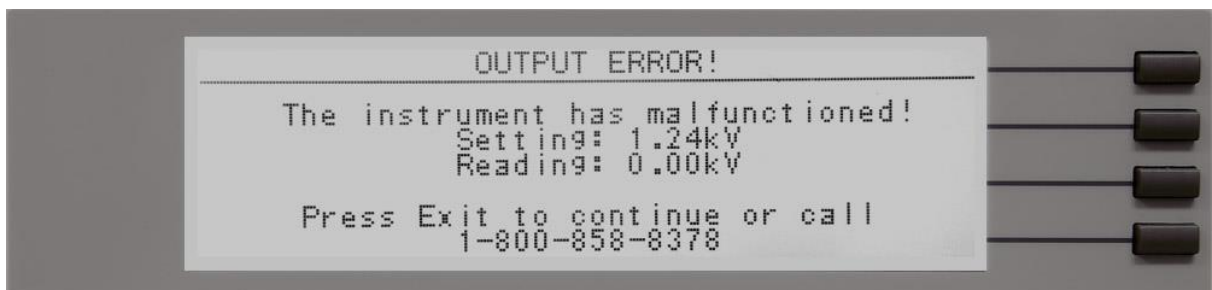

The RESET button is not active in this situation. Only the EXIT key will allow you to

return to the Perform Test screen.

Fatal Error: If the instrument has a Fatal Error failure then the following screen will appear:



All of the buttons and keys are not active in this situation. You should contact Associated Research, Inc to receive further instruction.

Fatal Error identification number will represent type of the failure that occurs.

Error number of 9002 will appear on the display, if the instrument's System data or Model/Option/Serial Number data are corrupted and does not match the setting.

Error number of 9003 will appear on the display, if the instrument's Calibration data is corrupted.

6. CONNECTION OF REMOTE I/O

Two 9-pin “D” type connectors mounted on the rear panel provide REMOTE-INPUT-OUTPUT control and information. These connectors mate with a standard 9 pin D-sub-miniature connector provided by the user. The output mates to a male (plug) connector while the input mates to a female (receptacle) connector. For best performance, a shielded cable should be used. To avoid ground loops the shield should not be grounded at both ends of the cable. Suggested AMP part numbers for interconnecting to the Remote I/O are shown below:

205204-4	PLUG SHELL WITH GROUND INDENTS
205203-3	RECEPTACLE SHELL
745254-7	CRIMP SNAP-IN PIN CONTACT (for plug)
745253-7	CRIMP SNAP-IN SOCKET CONTACT (for receptacle)
745171-1	SHIELDED CABLE CLAMP (for either plug or receptacle)
747784-3	JACKSCREW SET (2)

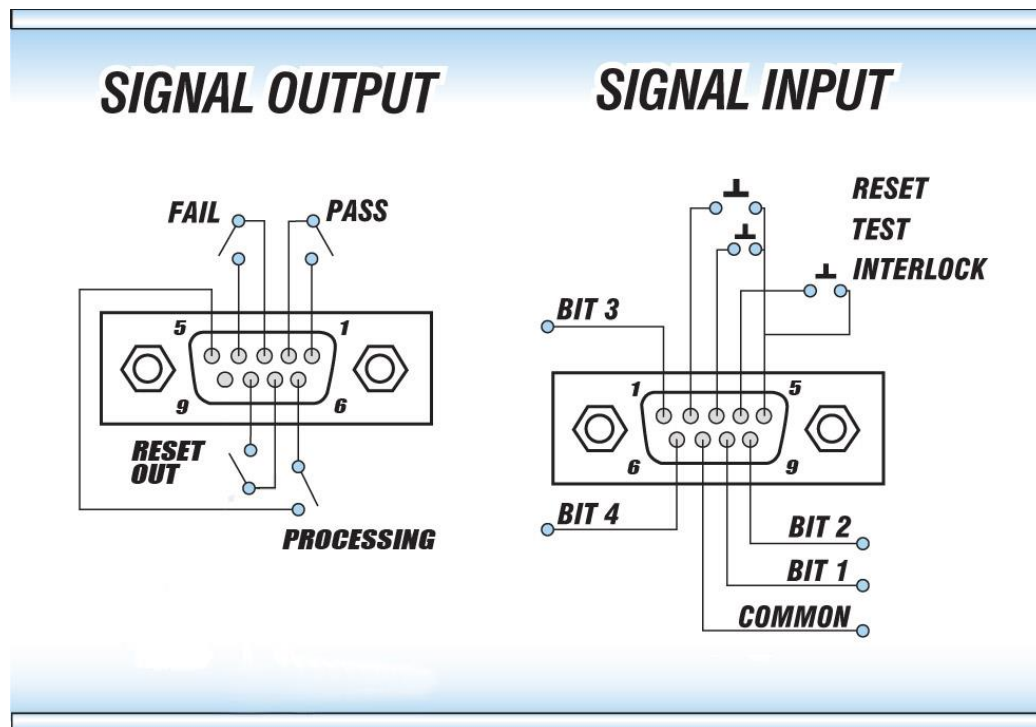

6.1. Remote Signal Outputs

The rear panel connector provides three output signals to remotely monitor PASS, FAIL, and PROCESSING conditions. The monitoring signals are provided by three normally open internal relays that toggle ON and OFF to indicate the condition of the tester. These are normally open free contacts and will not provide any voltage or current. The ratings of the contacts are 1 AAC / 125 VAC (0.5 ADC / 30 VDC). The signal outputs are provided on the 9-pin female “D” type connector. Below is a list that indicates what conditions activate each pin. When a terminal becomes active the relay closes thereby allowing the external voltage to operate an external device.

Pins 1 and 2 provide the PASS signal.
Pins 3 and 4 provide the FAIL signal.
Pins 5 and 6 provide the PROCESSING signal.
Pins 7 and 8 provide the RESET signal.

The following describes how the relays operate for each test condition:

PROCESSING – The relay contact closes the connection between pin (5) and pin (6) while the instrument is performing a test. The connection is opened at the end of the test.

PASS – The relay contact closes the connection between pin (1) and pin (2) after detecting that the item under test passed all tests. The connection is opened when the next test is initiated or the reset function is activated.

FAIL – The relay contact closes the connection between pin (3) and pin (4) after detecting that the item under test failed. The connection will open when the next test is initiated or the reset function activated.

RESET OUT – The relay contact closes the connection between pin (7) and pin (8) while the reset function is activated. This is only a continuous closure dependent on the length of time the reset button is held in an active state.

6.2. Remote Signal Inputs and Memory Access

The HypotULTRA III remote connector enables remote operation of the TEST, RESET, and REMOTE INTERLOCK functions, and allows the operator to select one of 10 pre-programmed test files.

When the PLC Remote mode is on, the HypotULTRA III will respond to simple switch or relay contacts closures. A normally open momentary switch can be wired across pins 3 and 5 to allow remote operation of the TEST function. A minimum pulse width or contact closure of 20mS is required to guarantee a test start. A normally open momentary switch can be wired across pins 2 and 5 to allow remote operation of the RESET function. A minimum pulse width or contact closure of 50mS is required to guarantee that a running test will abort. When the PLC remote function is (ON) the TEST switch on the front panel will be disabled to prevent a test from being activated through this switch. For safety, the front panel RESET switch remains active even when a remote reset switch is connected so that high voltage can be shut down from either location.

DID YOU KNOW?

The Remote Signal Input connector may be used with various accessories, including light curtains, foot switches, and safety probes. Contact Associated Research, Inc. for more information.

The Remote File Select function gives the user the capability to quickly change parameters and initiate a test remotely. Ten pre-programmed test files can be accessed by connecting pins 1,6,8, and 9 to the common pin 7, in different combinations. The memory select bits should be set simultaneously and remain set for a minimum of 20ms to guarantee that the correct memory will be selected. However, the memory select bits may be set in sequential manner, provided that the time delay between each bit is less than 4ms. When the desired bit pattern has been established it should remain set for a minimum of 20ms to guarantee that the correct memory will be selected. The **Remote File Select Truth Table** (binary) shows the different combinations of momentary switch (relay) closures, and which memory programs that will be selected as the result. It may be necessary to "OR" the momentary switches (relay contacts) to prevent incorrect program selection due to timing errors.

REMOTE FILE SELECT TRUTH TABLE				
BIT 4	BIT 3	BIT 2	BIT 1	FILE #
0	0	0	1	01
0	0	1	0	02
0	0	1	1	03
0	1	0	0	04
0	1	0	1	05
0	1	1	0	06
0	1	1	1	07
1	0	0	0	08
1	0	0	1	09
1	0	1	0	10
1= Momentary Contact closure between BIT and COMMON				
0= No Contact closure between BIT and COMMON				

WARNING

THAT MEMORY

ACTIVATING MEMORY PROGRAM FUNCTIONS THROUGH THE REMOTE CONNECTOR, SELECTS THE PROGRAM AND STARTS THE TEST WHICH IS PREPROGRAMMED INTO

CAUTION

DO NOT CONNECT VOLTAGE OR CURRENT TO THE SIGNAL INPUTS, THIS COULD RESULT IN DAMAGE TO THE CONTROL CIRCUITRY.

Remote Interlock

HypotULTRA III is equipped with a Remote Interlock feature. Remote Interlock utilizes a set of closed contacts to enable the instrument's output. If the Remote Interlock contacts are open the output of the instrument will be disabled. Remote Interlock could also be referred to as a remote system lockout, utilizing "fail when open" logic. If the Remote Interlock contacts are open and the TEST button is pushed, a pop-up message will be displayed on the screen for two seconds. The message will appear as follows:



If the Remote Interlock contacts are opened during a test, the pop-up message will be displayed and the test will abort. The hardware has been configured to provide the interlock connections on pins 4 and 5 of the Remote Interface, Signal Input port. The instrument can still be used without the external interlock device as long as the Interlock Disable Key (38075 provided with unit) is plugged into the Remote Interface, Signal Input port. If there is nothing connected to the Remote Interface, Signal Input port to provide a connection to the Remote Interlock, the instrument will not perform tests.



7. BUS REMOTE INTERFACE GPIB/USB/RS-232

This section provides information on the proper use and configuration of the bus remote interface. The USB/RS-232 remote interface is standard on the HypotULTRA III but the GPIB (IEEE-488) interface option can be substituted for the USB/RS-232 interface. Please refer to **Section 8. Options** for details on the HypotULTRA III options. The USB/RS-232 interface uses the same command set as the GPIB interface for setting test parameters; however, many functions of the GPIB 488.2 interface are not available through USB/RS-232. The IEEE-488 interface included with the HypotULTRA III conforms to the requirements of the IEEE-488.2 standard.

The USB/RS-232 interface card requires the user to download a driver in order for the instrument to recognize the USB interface. The driver can be found on the Associated Research, Inc. website:

<http://www.asresearch.com/products/software/USB-driver.aspx>

Click on “USB/RS-232 Driver” to download the driver. This link contains an automatic extract and install program. Follow the instructions of the installation program to initialize the driver install. NOTE: The USB port acts as a USB to RS-232 converter. As a result, the PC will recognize the USB port as a virtual COM port.

7.1. USB/RS-232 Interface

This interface provides all of the control commands and parameter setting commands of the GPIB interface with the exception of some of the 488.2 Common Commands and SRQ capability. All commands can be found in section **7.4. USB/RS-232/GPIB Command List**. The identification command *IDN and the Status Reporting commands are also available through USB/RS-232.

7.1.1. RS-232 Connector

The RS-232 cabling should be configured as follows for a 9-pin serial port interface:

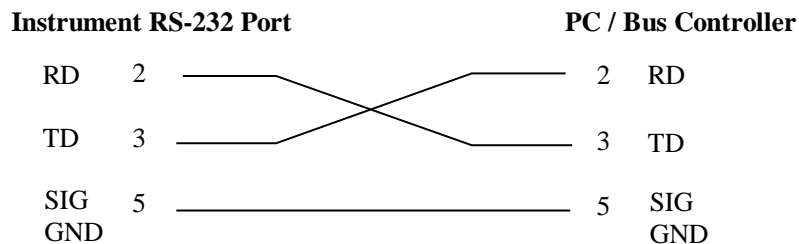

7.1.2. Communications Port Configuration

The COM port should have the following configuration:

- 9600 baud
- 8 data bits
- 1 stop bit

- No parity

This interface does not support XON/XOFF protocol or any hardware handshaking. The controller should be configured to ignore the handshaking lines DTR (pin 4), DSR (pin 6) CTS (pin 8) and RTS (pin 7). If the port cannot be configured through software to ignore these lines the handshake lines should be jumpered together in two different sets. Pins 4 and 6 should be jumpered together and pins 7 and 8 should be jumpered together at the controller end of the cable.

7.1.3. Sending and Receiving Commands

Sending Data

Once a command is sent to the instrument over the USB/RS-232 bus the instrument will send one of two responses. If the transfer was recognized and completed the instrument will return with 06 hex or 6 decimal, the Acknowledge (ACK) ASCII control code. If there is an error with the command string that is sent, the instrument will respond with 15 hex or 21 decimal, the Not Acknowledge (NAK) ASCII control code. The ACK or NAK response allows for software handshaking to monitor and control data flow.

Receiving Data

When requesting data from the instrument it will automatically send the data back to the controller input buffer. The controller input buffer will accumulate data being sent from the instrument, including the ACK and NAK response strings, until it has been read by the controller.

7.2. GPIB Interface

This interface is optional on the HypotULTRA III and provides all of the control commands and parameter setting commands of the USB/RS-232 interface along with 488.2 Common Commands and SRQ capability. All commands can be found in section **7.4. USB/RS-232/GPIB Command List**.

7.2.1. GPIB Connector

Connection is usually accomplished with a 24-conductor cable with a plug on one end and a connector at the other end. Devices may be connected in a linear, star or a combination configuration.

The standard connector is the Amphenol or Cinch Series 57 Microribbon or AMP CHAMP type. The GPIB uses negative logic with standard transistor-transistor logic (TTL) levels. When DAV is true, for example, it is a TTL low level (≤ 0.8 V), and when DAV is false, it is a TTL high level (≥ 2.0 V).

Restrictions and Limitations on the GPIB

- A maximum separation of 4 m between any two devices and an average separation of 2 m over the entire bus.

- A maximum total cable length of 20 m.
 - No more than 15 device loads connected to each bus, with no less than two-thirds powered on. For example 1 GPIB controller and a maximum of 14 GPIB instruments.
- **NOTE:** A bus extender, which is available from numerous manufacturers, is available to overcome these limitations.

7.2.2. GPIB Address

Each device on the GPIB (IEEE-488) interface must have a unique address. You can set the address of the HypotULTRA III to any value between 0 and 30. The address can only be set from the front panel. The address is stored in non-volatile memory and does not change when the power has been off or after a remote reset.

- **The address is set to 8 when the instrument is shipped from the factory.**

7.3. Interface Functions

The capability of a device connected to the bus is specified by its interface functions. These functions provide the means for a device to receive, process, and send messages over the bus. The interface functions are listed in the chart below.

GPIB 488.1 INTERFACE FUNCTIONS

INTERFACE FUNCTION	SUBSET	DESCRIPTION
Source Handshake	SH1	Complete Source handshake capability
Acceptor Handshake	AH1	Complete Acceptor handshake capability
Talker	T6	Talker functions (unaddress if MLA)
Listener	L4	Listener functions (unaddress if MTA)
Service Request	SR1	Complete Service request capability
Remote Local	RL0	No remote/local capability
Parallel Poll	PP0	No parallel poll capability
Device Clear	DC1	Complete Device clear capability
Device Trigger	DT0	No device trigger capability
Controller	C0	No controller capability
Electrical Interface	E2	Three-state drivers
Controllable Items	Test and Reset control.	
	Setting of test parameters for tests.	
	Reading of instrument status and test results.	
Data Codes	ASCII	
Delimiter	NL (+ EOI)	

7.4. USB/RS-232 / GPIB Interface Command List

Echo and Response Considerations

USB/RS-232 Responses

The USB/RS-232 bus will automatically send any response back to the controller's input buffer.

GPIB Queries and Responses

The HypotULTRA III GPIB bus will not send any data to the controller without being queried. A GPIB read command must be sent after a command string to retrieve any data from a query command (?).

7.4.1. Rules for Sending Commands to the Instrument

The following conventions are used to describe the commands syntax for HypotULTRA III:

- Braces ({ }) enclose each parameter for a command string.
- Triangle brackets (< >) indicate that you must substitute a value for the enclosed parameter.
- The Pipe (|) is used to separate different parameter options for a command.
- The command and the parameter data must be separated with a space.
- Each command string should be terminated by the ASCII control code, New Line (NL), (OAh) or the end of line (EOL) message for GPIB.
- All commands that end with a question mark (?) are query commands and required an IEEE-488 read command to retrieve the data from the device's output buffer.

7.4.2. Test Execution Commands

The following commands are used to control actual output voltage and current from the instrument. Please observe all safety precautions.

COMMAND	DESCRIPTION
TEST	Execute a Test
RESET	Abort a test in Process or Reset Failures
SAO	Set Auto-Offset
SACG	Set Auto-Charge-LO

TEST

Starts the test sequence at the selected step loaded into memory (RAM).

RESET

Stop or abort a test. Also used to reset a latched failure condition.

SAO

Set the offset for the Continuity test. The cables and any test fixture should be connected before executing the command. This command will perform an actual test and all safety precautions should be observed when using this command.

SACG

Set the Charge-LO parameter for the DCW or IR test. The cables and any test fixture should be connected before executing the command. The test parameters that are set for the step will be used when performing the auto setting. This command will perform an actual test and all safety precautions should be observed when using this command.

7.4.3. File Editing Commands

The following commands are used to create or modify Test Setup Files.

- Commands should be separated from parameters by a space.
- If multiple parameters are entered, they should be separated by commas.

COMMAND	DESCRIPTION	VALUE
FL <memory number>	File Load	memory number = 1-50
FN <file name>	File Name	file name = Valid ASCII (1) maximum 11 characters
SS <step number>	Step Select step number	step number = 1-30
SAA	Step Add ACW test	
SAD	Step Add DCW test	
SAI	Step Add IR test	
SAC	Step Add CONT test	
ADD <test,p1,p2,p3...>	Add all parameters of a test	
SP <prompt message>	Step Prompt Create	prompt message = Valid ASCII (1) maximum 32 characters
SP	Step Prompt Delete	
SF {1 0}	Step Fail Stop	1=On, 0=Off

(1) "Valid ASCII" is the character set that is available from the front panel LCD user interface. Consisting of upper case alphabet (A-Z), numbers (0-9) and decimal point (.), asterisk (*), dash (-), under bar (_), tilde (~) and space (SP).

FL <memory number>

Load a file by memory number from non-volatile memory into random access memory RAM.

FN < file name>

Creates a new file name for the active memory loaded into RAM.

SS <step number>

Selects the active selected step to load into RAM. The step must first be selected before any specific parameters can be edited.

SAA, SAD, SAI, SAC

These commands add the appropriate test type within the memory at the step location that has been selected. The parameters of the previous test type will be deleted and the default values for the new test type will be recalled. If the same test type is selected that already exists, the default values will replace the previous parameters.

ADD <test p1,p2,p3...>

This command edits all parameters in a step. Parameters will be edited at the step location that has been selected. See the command summary tables below to see the specific test type for each of these commands

The parameter <test> indicates the test type. The values ACW, DCW, IR, or CONT must be used. The parameters <p1,p2> etc. indicate the individual settings for each parameter of the test. All parameters must be included with the command and should appear in the same order that is shown in the table below. Also, like the individual parameter editing commands, the unit should not be included with the value; only the numeric value should be included in the command string. When the scanners are being used they should be appended to the end of the string, with the internal scanner first if installed, followed by the external scanner if connected to the rear panel scanner control port.

The list of parameters can also be found in the default parameters section of the manual, or refer to **Section 7.4.5 Test Parameter Editing Commands and Companion Queries** for the proper values.

The parameter values for file editing commands should use complete text (i.e. "ON" and "OFF" or "Real" and "Total") and not use the coded values that are associated with the test parameter setting commands discussed in **Section 7.4.5 Test Parameter Editing Commands and Companion Queries**. The LS? companion command will also list all parameters in complete text in the order as they appear in the following table, preceded by the step number.

	ACW	DCW	IR	CONT
1	Voltage	Voltage	Voltage	Max-Limit
2	Max-Lmt Total	Max-Lmt	Max-Lmt	Min-Lmt
3	Min-Limit Total	Min-Limit	Min-Limit	Dwell
4	Ramp Up	Ramp Up	Ramp Up	Offset
5	Dwell Time	Dwell Time	Delay Time	Connect (ON/OFF)
6	Ramp Down	Ramp Down	Ramp Down	Internal Scanner (opt)
7	Arc Sense	Charge-LO	Charge-LO	External Scanner (opt)
8	Max-Lmt Real	Arc Sense	Connect (ON/OFF)	
9	Min-Lmt Real	Ramp-HI (ON/OFF)	Internal Scanner (opt)	
10	Frequency (50/60)	Arc Detect (ON/OFF)	External Scanner (opt)	
11	Arc Detect (ON/OFF)	Continuity (ON/OFF)		
12	Continuity (ON/OFF)	Connect (ON/OFF)		
13	Display (Real/Total)	Internal Scanner (opt)		
14	Connect (ON/OFF)	External Scanner (opt)		
15	Internal Scanner (opt)			
16	External Scanner (opt)			

SP <prompt message>

Adds or edits a prompt message for the active step.

SP

Removes or deletes the prompt that had been created for the active step.

7.4.4. Test Parameter Editing Commands and Companion Queries

These commands are used to modify the test parameter within each step. These commands require a parameter value to be included with the command. The companion query command will read the parameter. The writing of the parameter requires that the unit not be included with the value, only the numeric value should be included with the command. Also, when the query commands are used the response will not include the unit's characters. Many of the commands will function the same way for multiple test types; however, the input range may be different and therefore

used a different possible set of values.

COMMAND	NAME	TEST TYPES	VALUE
ECC {1 0} ECC?	Edit Connect	ALL	1= On, 0=Off
ED {1 0} ED?	Edit Current Meter Display	ACW	1 = Real, 0 = Total
EV <value> EV?	Edit Voltage	ACW DCW IR	0 - 5000V 0 - 5000V 50 - 1000V
ECG < value > ECG?	Edit Charge-Lo	DCW IR	0.0 - 350.0uA 0.000 - 3.500uA
ECT {1 0} ECT?	Edit Continuity	ACW DCW	1= On, 0=Off
ERU < value> ERU?	Edit Ramp-Up	ACW DCW IR	0.1 - 999.9s
ERD <value > ERD?	Edit Ramp-Down	ACW DCW IR	0.0 - 999.9s 0, 1.0 - 999.9s 0, 1.0 - 999.9s
ERH {1 0} ERH?	Edit Ramp-HI	DCW	1= On, 0=Off
EDW < value > EDW?	Edit Dwell	ACW DCW CONT	0, 0.4 - 999.9s 0, 0.4 - 999.9s 0, 0.3 - 999.9s
EDE < value > EDE?	Edit Delay	IR	0, 1.0 - 999.9s
EO < value > EO?	Edit Offset	CONT	0.00 - 10.00Ω
EA < value > EA?	Edit Arc	ACW DCW	1 - 9
EAD {1 0} EAD?	Edit Arc-Detect	ACW DCW	1= On, 0=Off
EHT < value > EHT?	Edit Max-Lmt-T	ACW	0.000 - 30.00mA
EHR < value > EHR?	Edit Max-Lmt-R	ACW	0.000 - 30.00mA
EH < value > EH?	Edit Max-Lmt	DCW IR CONT	0.0 - 10000uA 0, 0.05 - 50000MΩ 0, 0.00 - 2000Ω
ELT < value > ELT?	Edit Min-Lmt-T	ACW	0.000 - 30.00mA
ELR < value > ELR?	Edit Min-Limit-R	ACW	0.000 - 30.00mA

COMMAND	NAME	TEST TYPES	VALUE
EL < value > EL?	Edit Min-Lmt	DCW IR CONT	0.0 - 10000uA 0.05 - 50000MΩ 0.0 - 2000 Ω
EF {1 0} EF?	Edit Frequency	ACW	1=60Hz, 0=50Hz
EIS <scanner string> EIS?	Edit Internal Scanner	ACW DCW IR CONT	scanner string = 1-16 element ASCII string consisting of H, L, or O. H=HV or Cont. , L=RETURN, O=OPEN
EES EES?	Edit External Scanner	ACW DCW IR CONT	scanner string = 1-16 element ASCII string consisting of H, L, or O. H=HV or Cont., L=RETURN, O=OPEN

7.4.5. System Parameter Editing Commands and Companion Queries

These commands are used to modify the system parameters for the instrument. These commands require a parameter value to be included with the command. The companion query command will read the parameter using the same value that is used for setting the parameter.

COMMAND	NAME	VALUE
SPR {1 0} SPR?	PLC Remote	1= On, 0=Off
SSI {1 0} SSI?	Single Step	1= On, 0=Off
SF {1 0} SF?	Fail Stop	1= On, 0=Off
SAL < value > SAL?	Alarm Volume	0-9
SC < value > SC?	Contrast	1-9
SL {1 0} SL?	Lock	1= On, 0=Off
SML {1 0} SML?	Memory Lock	1= On, 0=Off
SSG {1 0} SSG?	Smart GFI	1= On, 0=Off
SR {2 1 0} SR?	Results	0=ALL, 1=P/F, 2=LAST
SCA {1 0} SCA?	Cal Alert	1= On, 0=Off

COMMAND	NAME	VALUE
SCDA < value > SCDA?	Cal Date	mm,dd,yy or yy,mm,dd or dd,mm,yy according to SDF setting
SCDU < value > SCDU?	Cal Due	mm,dd,yy or yy,mm,dd or dd,mm,yy according to SDF setting
SA < value > SA?	Alert Date	mm,dd,yy or yy,mm,dd or dd,mm,yy according to SDF setting
SD < value > SD?	Date	mm,dd,yy or yy,mm,dd or dd,mm,yy according to SDF setting
SDF < value > SDF?	Date Format	0=yy,mm,dd, 1=mm,dd,yy, 2=dd,mm,yy
ST < value > ST?	Time	hh,mm (24hr) hh,mm,AM or hh,mm,PM (12hr) according to STF setting
STF {1 0} STF?	Time Format	0=12hr, 1=24hr
SD1 < value > SD1?	Device ID	0 - 9999999
SD2 {1 0} SD2?	Device ID	1= On, 0=Off
SPM {2 1 0} SPM?	Print Mode	0=AUTO, 1=MANUAL, 2=OFF
SPRE {1 0} SPRE?	Prn Result n	1=FAIL, 0=ALL
SPS {1 0} SPS?	Prn Setting n	1= On, 0=Off
SFF {1 0} SFF?	Form Feed n	1= On, 0=Off

7.4.6. Query Commands

These query commands will retrieve data from the instrument. The GPIB bus application requires an IEEE-488 read command to be sent after the query command. These commands include functions for retrieving test data, test results and remote hardware status as well as setup file information.

COMMAND	NAME	VALUE
TD?	List Testing Data	Test In Process
RD <step number>?	List Results Data	<i>step number = 1-30</i>
RR?	Read Remote Reset	1=Open, 0=Closed
RI?	Read Remote Interlock	1=Open, 0=Closed
RS?	Read Scanner Status	0 = None, 1 = Internal 2 = External, 3 = Both
LF?	List File Name	Active selected memory
LFN?	List Memory (File) Number	Active selected memory
LF <memory number>?	List File Name by memory number	<i>memory number = 1-50</i>
LP?	List Prompt	Active selected Step
LP <step number>?	List Prompt by step number	<i>step number = 1-30</i>
LS?	List Step Parameters	
LS <step number>?	List Step Parameters by step number	<i>step number = 1-30</i>

TD?

Read the active data being displayed on the LCD display while the test is in process. Will also read the last data taken when the test sequence has completed. Each parameter is separated by commas and includes step number, test type, test status, and metering. The syntax for this command response is {step, test type, status, meter 1, meter 2, meter 3}. ACW test displays 4 meters. Each meter will contain only the value and not the units. In the case of DCW current where both uA and mA are used on the display, the command response will always indicate the current in uA for example 2.0mA will respond with 2000 for 2000uA.

RD <step number>?

Read the results for an individual step. The step number is the actual step number that has been saved within the file, not the order of which the steps were executed. For example if the test was executed starting from step 3 and ending with step 5 then the first step test results will be found in location 3 not in location 1. Each parameter is separated by commas and includes step number, test type, test status, and metering. The syntax for this command response is {step, test type, status, meter 1, meter 2, meter 3}. ACW test displays 4 meters. Each meter will contain only the value and not the units. In the case of DCW current where both uA and mA are used on the display the command response will always indicate the current in uA for example 2.0mA will respond with 2000 for 2000uA.

RR?

Read the remote Reset input signal. When the remote reset has been activated by closing the contacts the query will return a value of 1 to indicate the instrument is being Reset.

RI?

Read the remote Interlock input signal. When the remote Interlock has been activated by opening the contacts the query will return a value of 0 to indicate the instrument is in the Interlock state and will not be able to generate output voltage or current.

RS?

Read Scanner Status command will respond with a value that identifies the number of scanners installed or connected to the instrument. Values 0 – 4 will indicate if there are no scanners connected, one Internal or External scanner, or if both an Internal and an External scanner are connected.

LF?

Lists the file name of the memory loaded into active memory (RAM).

LFN?

Lists the memory number of the active memory file loaded into active memory (RAM).

LF <memory number>?

List the file name of any of the 50 memories.

LP?

Lists the prompt that is created for the selected step within active memory (RAM).

LP <step number>?

Lists the prompt that has been created for a particular step of the file within active memory (RAM).

LS?

Lists all the parameters for the individual step that is currently selected. See the ADD command for the list of parameters. A comma (,) will separate each parameter and will be preceded with the step number.

LS <step number>?

Lists all the parameters for the individual step indicated by *step number* = 1-30. See the ADD command for the list of parameters. A comma (,) will separate each parameter and will be preceded with the step number.

7.4.7. IEEE 488.2 Common Commands

These commands are required by the IEEE-488.2 standard with the exception of *PSC, *PSC?. Most of these commands are not available over the USB/RS-232 bus except for the *IDN? command which can be used to retrieve the instrument identification information, and the four status reporting commands *ESR?, *ESE, *ESE? and *STB?

COMMAND	NAME	DESCRIPTION
*IDN?	Identification Query	Associated Research Inc., Model Number, Serial Number, Firmware

COMMAND	NAME	DESCRIPTION
		Revision
*RST	Reset Command	Resets HYPOTULTRA III
*TST?	Self-Test Query	00H=OK 01H=TEST EEPROM ERROR
*CLS	Clear Status Command	Clear Standard Event Status Register Clear Service Request Register
*OPC	Operation Complete Command	When all selected pending operations complete, ESR BIT0=1
*OPC?	Operation Complete Query	When all selected pending operations complete, Output Queue=1
*WAI	Wait-to-Continue Command	
*PSC {1 0}	Power-on Status Clear Command	1 = Power-on clear enable registers 0 = Power-on load previous enable registers
*PSC?	Power-on Status Clear Query	
*ESR?	Standard Event Status Register Query	0 - 255
*ESE <value>	Standard Event Status Enable Command	value = 0 - 255
*ESE?	Standard Event Status Enable Query	0 - 255
*STB?	Read Status Byte Query	Read Status Byte
*SRE <value>	Service Request Enable Command	value = 0 - 255
*SRE?	Service Request Enable Query	0 - 255

***IDN?**

Read the instrument identification string. Company = Associated Research Inc.

***RST**

Reset the instrument to original power on configuration. Does not clear Enable register for Standard Summary Status or Standard Event Registers. Does not clear the output queue. Does not clear the power-on-status-clear flag.

***TST?**

Performs a self-test of the instrument data memory. Returns 0 if it is successful or 1 if the test fails.

***CLS**

Clears the Status Byte Summary register and Event registers. Does not clear the

Enable registers.

***OPC**

Sets the operation complete bit (bit 0) in the Standard Event register after a command is completed successfully.

***OPC?**

Returns an ASCII "1" after the command is executed.

***WAI**

After the command is executed, it prevents the instrument from executing any further query or commands until the no-operation-pending flag is TRUE.

***PSC {1|0}**

Sets the power-on status clear bit. When set to 1 the Standard Event Enable register and Status Byte Enable registers will be cleared when power is turned ON. 0 setting indicates the Enable registers will be loaded with Enable register masks from non-volatile memory at power ON.

***PSC?**

Queries the power-on status clear setting. Returns 0 or 1.

***ESR?**

Queries the Standard Event register. Returns the decimal value of the binary-weighted sum of bits.

***ESE <value>**

Standard Event Enable register controls which bits will be logically OR'd together to generate the Event Summary bit 5 (ESB) within the Status Byte.

***ESE?**

Queries the Standard Event enable register. Returns the decimal value of the binary-weighted sum of bits.

***STB?**

Read the Status Byte. Returns the decimal value of the binary-weighted sum of bits.

***SRE <value>**

Service Request Enable register controls which bits from the Status Byte should be used to generate a service request when the bit value = 1.

***SRE?**

Queries the Service Request enable register. Returns the decimal value of binary-weighted sum of bits.

7.4.8. Status Reporting

The status reporting system is configured using two types of registers. An Event register and a Summary register. The Summary register is known as the Status Byte register and records high-level summary information acquired by the Event registers.

An Event register report defines conditions or messages at each bit. The bits are latched and remain at an active state until the register is either Read or Cleared. Reading the Event register automatically clears the register and sets all bits to inactive state or 0. When querying an Event register the information is returned as a decimal number representing the binary-weighted sum of all bits within the register.

The Enable registers bits represent the selection of bits that will be logically OR'd together to form the summary bit in the Status Byte. The *CLS command will not clear the Enable registers and if you wish to clear the register you must set it to a value of 0. Like the Event register, the enable register is represented as a decimal number that equals the binary-weighted sum of all bits.

The Enable register will clear to value a of 0 at power up unless the *PSC 0 command had been executed before power-off. The *PSC command tells the device whether or not it should clear the Enable registers at power-on. Using this command will allow SQRs to function immediately after power-on.

Bit	Binary weight	EVENT REGISTER		STATUS BYTE REGISTER	
		Event Register	Enable Register	Summary Register	Enable Register
0	1	Operation Complete		ALL PASS	
1	2	not used		FAIL	
2	4	Query Error		ABORT	
3	8	Device Error		TEST IN PROCESS	
4	16	Execution Error		Message Available (MAV)	
5	32	Command Error		Event Summary Bit (ESB)	
6	64	not used		Request Service (RQS) or Master Summary Status (MSS)	not used
7	128	Power On		PROMPT	

*ESR?

*ESE
*ESE?

*STB? | SPOLL

*SRE
*SRE?

7.4.9. GPIB Service Request

The service request capability is not available with the USB/RS-232 interface. The SRQ line will be activated only after one or more of the service request functions have been enabled using the Status Byte Enable register command *SRE.

The Status Byte bit assignments are as described in the previous section for status reporting. When the instrument has requested service, the enabled bit or bits and the RQS bit 6 will be active or 1. Bits 4, 5, and 7 are not used and will be set to false, or 0 for all Status Byte reads.

After the serial poll (SPOLL) is executed the RQS bit will be cleared to 0, and the remaining bits will remain unchanged. The Status Byte will not change value until the event register is read and cleared for the corresponding Status Byte bit.

For example after the All Pass SRQ has been enabled, when the test(s) have finished with pass indications the instrument will set the hardware SRQ line and output the Status Byte of 41 hex. This means that bit 6 and bit 0 are set to a value of 1. After reading the Status Byte the Status Byte value will change to 01 hex.

7.5. Non Volatile Memory

The instrument saves each parameter in non-volatile memory when the parameters are sent to the instrument. The non-volatile memory has a limited write cycle life, therefore programmers who wish to send all parameters before executing each test, should use Memory 50 step 30. The parameters will be stored in the CPU's Random Access Memory (RAM) until another memory location is selected. However, settings written to RAM from GPIB/USB/RS-232 mode will be lost when power is shut down. Parameter changes to RAM are unlimited and will not affect the life of the internal non-volatile memory chip.

FOR MORE INFORMATION ON IEEE (GPIB) PLEASE CONTACT

The Institute of Electrical and Electronic Engineers, Inc.
345 East 47th Street,
New York, NY 10017
☎ 1-212-705-7018 (Communications Society of IEEE)
Internet: www.ieee.org

8. OPTIONS

Introduction

This section contains a list and descriptions of available factory installed options at the time of this printing. The list of options contains an option code number that can be referenced on the data plate on the rear panel of the unit.

Option Label

On the rear panel of the instrument, you will find a label that contains the option code.

For example, your options code would appear as follows:

Fitted with option 01..... OPT: 01
 Fitted with option 01 and 08..... OPT: 0108

HypotULTRA III Options

Option List

CODE	DESCRIPTION
01	Internal 8 Channel Scanner with Continuity
02	Internal 4 Channel Scanner with Continuity
06	Dual Remote Test Switches
08	Printer Card
10	GPIB
14	3mA AC Output
15	5mA Output
16	Ethernet Card
17	Data Storage Card

01 8 Channel Scanner with Continuity

The Scanner option provides 8 high voltage/continuity channels on the rear panel of the HypotULTRA III. The high voltage/continuity channels can be set to a High (H) or Low (L) level giving the operator the capability to test from one channel to another channel or from any channel to a common Low or Return point. The channels can be connected in parallel if desired but there is only one leakage current measurement for all channels.

The Scanner will provide output to multiple test points and will have the same operation specifications that apply to the standard instrument.

Setting up the scanner channels

1. From the Test Parameter Review screen (refer to **Section 4.3. Test Setup**), scroll the highlighted area to the Scanner parameter using the "< ,

- >, ^, v” soft keys.
2. Press the “Edit” soft key. The Scanner Channel Edit screen will now be displayed.
 3. Use the “<, >” soft keys to select which Scanner channel you want to edit then press the change key to select H, L, O. The three different selectable Scanner states are L (Scanner channel set to the return point), H (Scanner set to the high voltage point or continuity output) and O (OFF). Once the channel is set, press ENTER to accept the new setting or EXIT to cancel.

Reviewing the Scanner Settings

From the Perform Tests screen, press the “Step” soft key. The soft keys will now change to “Step -,” “Step +,” and “Edit.” The display will appear as follows:

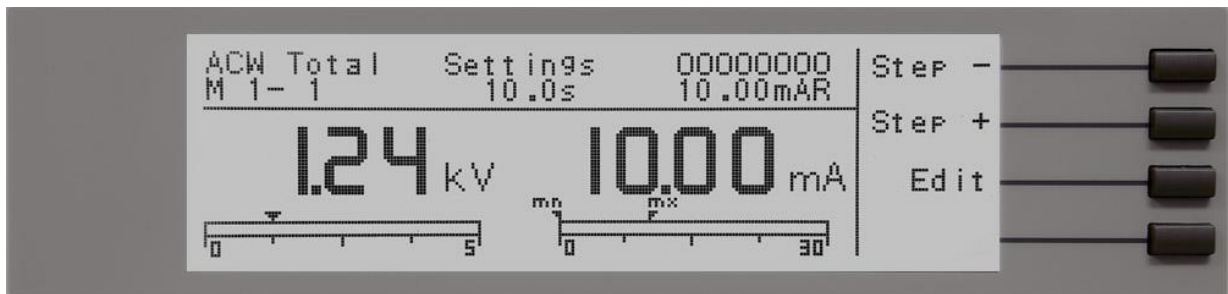

When the Scanner is installed, a Scanner status display will replace the memory name. This feature allows you to quickly review the Scanner settings of the individual steps by pressing the “Step +” and “Step-” soft keys.

Running Scanner Status

When the Scanner is installed, a live Scanner status will appear in the upper right corner of the display while a test is being performed.

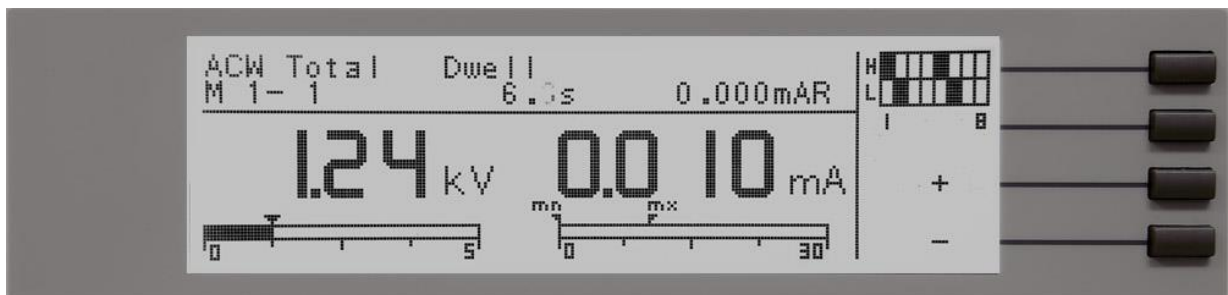

The live Scanner Status gives direct visual feedback of the state of all eight Scanner channels. The numbers indicate the channel numbers from left to right and the blocks represent channels 1-8. A darkened “H” block indicates that channel is set to be a high voltage/continuity output. A darkened “L” block indicates the channel is set to be a return connection. An open block indicates that the Scanner channel is set to OFF.

02 4 Channel Scanner with Continuity

This option is the same as Option 01, 8 Channel Scanner with Continuity, with the exception that the numbers of channels are limited to 4. The Scanner functions the same as the 8-channel option but the Scanner status display will only indicate the status of channels 1-4, even though all 8 channel indicators are displayed.

06 Dual Remote Test Switches

The Dual Remote Test Switch option allows the user to configure dual palm switches for safe production line operation.

To activate the option, press the System key to open the System menu. The System screen will appear as follows:

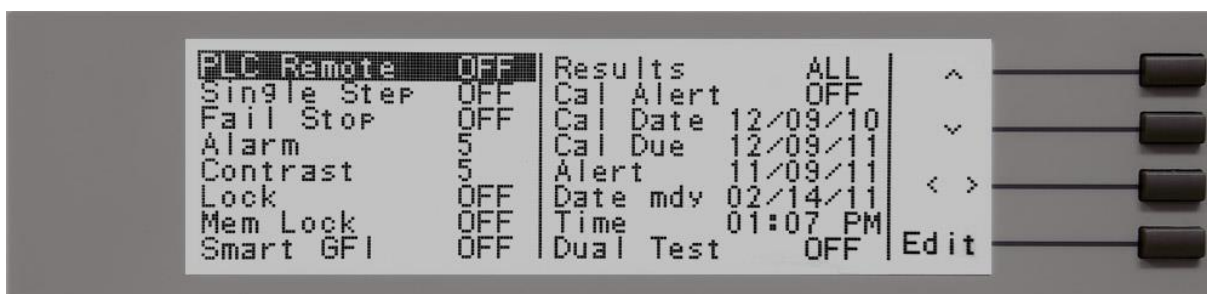

- **NOTE:** If the GPIB or Printer Options are installed, the System menu will look different and will consist of two pages with the Dual Test parameter appearing on the second page.

Scroll through the System Menu using the “^, v” soft keys and change PLC Remote to ON and Dual Test to ON.

The rear panel remote interface is reconfigured to allow two test switches instead of the standard reset and test inputs. The two test switches have to be pressed within 0.5 seconds to activate the test process. The two test switches must remain closed to continue the test. If either of the test switches is released, the process will be shut down immediately. The functions of the TEST and RESET switches on the front panel will be disabled if the dual test switches are enabled. When the Dual Test parameter is turned OFF, the TEST and RESET switches on the front and rear panel behave the same as the standard instrument, and are controlled by the PLC Remote On/Off selection.

08 Printer Port Option

This option allows the instrument to generate a hardcopy printout of the test results. The printout can be configured to print automatically with each test or manually by pressing a front panel key. There is also the capability to enter a device ID number for each test that will increment automatically after each test is performed. The test can be further configured to print only results from tests that have failed or to print all test results from every test performed.

The Printer Port is a USB interface and should be compatible with most USB printers. The printer port output uses simple ASCII characters and control codes. Simply connect the printer to the HypotULTRA III and configure the printer output using the Setup Systems menu. At the System Setup screen, scroll the highlighted area to <more>. The Print Format setting screen will now be displayed. From the Print Format setting screen, six different parameters may be accessed; Device ID number, Mode, Test Result, Test Setting, Device ID, and Form Feed. The Print Format setting screen will appear as follows:



Mode

From the Print Format setting screen, press the “Mode” soft key. As the soft key is pressed, the mode will change between three available print modes: Auto, Manual and OFF.

In the Auto mode, the HypotULTRA III will automatically send the test results to the printer at the end of every complete test. The ENTER key may also be used from the end of test summary screen or the results screen to create additional printouts as needed.

In the manual mode, there are three different ways to create a printout. The first method is to press the ENTER key at the end of a test. The second method is to press the ENTER key from the Results screen. The third way is to press the Print Results soft key from the Perform Test screen.

In the OFF mode, the printer card and printer menu are disabled.

Test Result

From the Print Format Setting screen, press the “Test Result” soft key. As the soft key is pressed the display will toggle between the words “All” and “Fail only”. This command selects which test results will be printed. “All”, selects printing all test results and “Fail only”, selects printing only failed test results.

Test Setting

From the Print Format Setting screen you may turn the Test Setting print enable ON and OFF by pressing the “Test Setting” soft key. This command selects printing the test parameters as well as the test results.

Device ID

The Device ID number is a counter that increments once every time a test is performed. The number can be set to match the exact serial number or some portion of the actual serial number of the item under test, or just used as an identifier or tracking number. From the Print Format Setting screen use the numeric keypad to select the initial Device ID. Finish by pressing the ENTER key. This number is not saved as part of the non-volatile system parameters; therefore, each time the power to the instrument is turned off the number will be reset to 1.

Form Feed

From the Print Format Setting screen, you may turn the Form Feed ON and OFF by pressing the “Form Feed” soft key. This command forces a form feed after each complete test sequence. When the form feed is turned off, the signature line will not appear. When the form feed is turned off the pages will break whenever the page is determined to be full by the printer.

10 GPIB Interface

This option may be substituted for the RS232 interface. This option provides all of the function control of the RS232 interface with the addition of SRQ functions. All commands can be found in section 7. Bus Remote Interface GPIB/USB/RS-232 of this manual.

14 3 mA AC Output

The 3 mA AC Output option limits the AC Dielectric Withstand Mode output current with software control. The trip points are adjusted to a maximum of 3 mA and the software has been modified so the high-speed maximum current shutdown is fixed at 3 mA.

The revised Dielectric Withstand Test Mode specifications are as follows.

DIELECTRIC WITHSTAND TEST MODE	
Output Rating	5 KV @ 3 mA AC 5 KV @ 10 mA DC for 7650 only
Max and Min-Limit	
AC Total	Range 1: 0.000 – 3.000 mA Resolution: 0.001mA Accuracy: ± (2% of setting + 2 counts)
AC Real	Range 1: 0.000 – 3.000mA Resolution: 0.001mA Accuracy: ± (3% of reading + 0.05mA) PF > 0.1 V > 250VAC

DIELECTRIC WITHSTAND TEST MODE	
DC	Range 1: 0.0 – 999.9 μ A for 7650 only Resolution: 0.1 μ A Range 2: 1000 – 10000 μ A for 7650 only Resolution: 1 μ A Accuracy: \pm (2% of setting + 2 counts)
Current Display	Auto Range
AC Total	Range 1: 0.000mA – 3.000mA Resolution: 0.001mA Accuracy: \pm (2% of setting + 2 counts)
AC Real	Range : 0.000mA – 3.000mA Resolution: 0.001mA Accuracy: \pm (3% of reading + 0.05mA) PF > 0.1 V > 250VAC
DC	Range 1: 0.0 μ A – 350.0 μ A for 7650 only Resolution: 0.1 μ A Range 2: 0.300 mA – 3.500 mA for 7650 only Resolution: 0.001mA Range 3: 3.00 mA – 9.99 mA for 7650 only Resolution: 0.01mA Accuracy: \pm (2% of reading + 2 counts)

15 5mA Output

The 5mA Output option limits the output current with software control. The trip points are adjusted to a maximum of 5mA and the software has been modified so the high-speed maximum current shutdown is fixed at 5mA. The following specifications have been changed for this option:

DIELECTRIC WITHSTAND TEST MODE	
Output Rating	5 KV @ 5 mA AC 5 KV @ 5 mA DC for 7650 only
Max and Min-Limit	
AC Total	Range 1: 0.000 – 5.000mA Resolution: 0.001mA Accuracy: \pm (2% of setting + 2 counts)

DIELECTRIC WITHSTAND TEST MODE	
AC Real	Range 1: 0.000 – 5.000mA Resolution: 0.001mA Accuracy: \pm (3% of setting + 0.05mA) All Ranges PF > 0.1 V > 250VAC
DC	Range 1: 0.0 – 999.9 μ A for 7650 only Resolution: 0.1 μ A Range 2: 1000 – 5000 μ A for 7650 only Resolution: 1 μ A Accuracy: \pm (2% of setting + 2 counts)
Current Display	Auto Range
AC Total	Range 1: 0.000mA – 3.500mA Resolution: 0.001mA Range 2: 3.00 – 5.00 mA Resolution: 0.01 mA Accuracy: \pm (2% of reading + 2 counts)
AC Real	Range : 0.000mA – 5.000mA Resolution: 0.001mA Accuracy: \pm (3% of reading + 0.05mA) All Ranges PF > 0.1 V > 250VAC
DC	Range 1: 0.0 μ A – 350.0 μ A for 7650 only Resolution: 0.1 μ A Range 2: 0.300 mA – 3.500 mA for 7650 only Resolution: 0.001mA Range 3: 3.00 mA – 5.00 mA for 7650 only Resolution: 0.01mA Accuracy: \pm (2% of reading + 2 counts)

16 Ethernet Card

The Ethernet Card option provides RS-232 and Ethernet communication interfaces, as well as barcode scanning capability.

The Ethernet Card has three input/output ports, shown in the following figure:

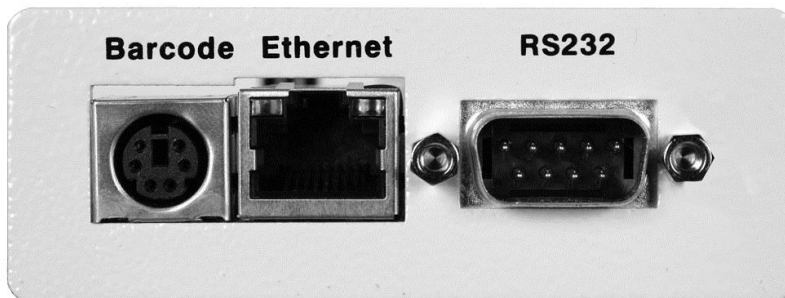

The port labeled “Barcode” is a PS/2-type connector that is used for the connection of a barcode scanner. The Ethernet port is for use with a standard CAT-5 Ethernet cable and may be connected to any compatible PC. The 9-pin D-type subminiature connector labeled “RS232” is for connection of the HypotULTRA III to an RS-232 communication bus.

RS-232 Interface

The protocol for interfacing and communicating using the RS-232 interface can be found in section **8. Bus Remote Interface GPIB/USB/RS-232** of this manual.

Ethernet Interface

The Ethernet interface provides all of the function control of the standard RS-232 interface. Some commands are only exclusive to GPIB control.

Default Settings

The default settings for the Ethernet interface are as follows:

IP Setup: AUTO
IP Address: 010.000.000.000
Gateway IP: 000.000.000.000
Subnet Mask: 255.000.000.000

The source port number for the Ethernet Card in TCP connections is 10001.

Ethernet Card Setup

In order to setup the Ethernet card, the operator will need information from the local network administrator. Please have your network administrator fill out the required information on the next page and keep it for your records:

Associated Research, Inc.
Ethernet Card Communications Information
(To be completed by Network Administrator)

Ethernet Card Address: _____:_____:_____:_____:_____

Device Name: _____

Device IP Address: _____.

Gateway IP Address: _____.

Subnet Mask: _____.

Saving New Settings

Any time the user edits one of the Ethernet Card parameters and exits the Ethernet Card Settings menu, the following message will be displayed:



The Ethernet Card will attempt to re-establish a connection with the server anytime the user modifies a parameter and exits the Ethernet Card Parameters Menu or uses the command set at the end of this option description. Thus, if the IP Setup is set to AUTO, the Ethernet Card will request a new IP Address every time a parameter is edited and, as a result, the “Requesting IP Address. . .” message will appear.

Power Up

The Ethernet Card will be installed with the default options listed above. After the HypotULTRA III initially powers up, the following pop-up message will appear:



- **NOTE:** The “Requesting IP Address...” pop-up message only appears at power up when the Ethernet Card has its IP Setup configured to AUTO.

There are two options to choose from this screen. Press the EXIT key to escape from this screen and stop the HypotULTRA III from requesting an IP address or allow the HypotULTRA III to request an IP address automatically from the network to which it is connected.

The Ethernet Card will wait for an IP Address for approximately 20 seconds. If the HypotULTRA III successfully receives an IP Address from the server the following pop-up message will be displayed:



If the HypotULTRA III fails to receive an IP Address after approximately 20 seconds, the following pop-up message will be displayed:



Press the EXIT key to remove the pop-up message and return to the HypotULTRA III's Perform Tests screen.

Ethernet Card Menu

When the Ethernet Card option is installed, the "ENET" soft key will appear in the Perform Tests screen as shown below:

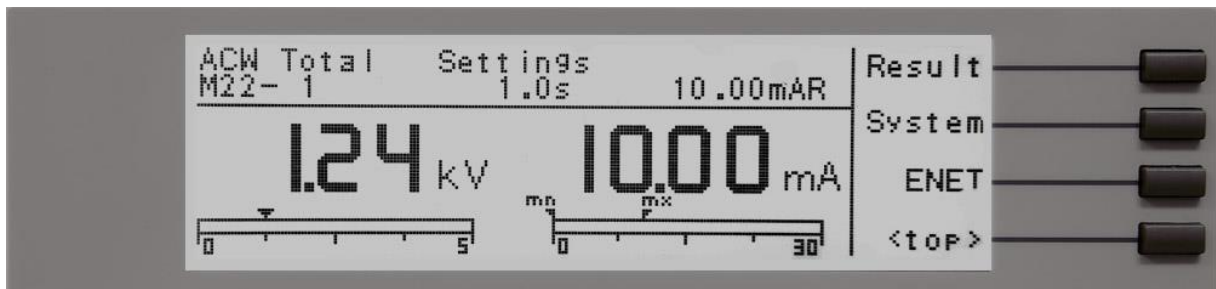

To access the Ethernet Card Menu, press the <more> soft key at the Perform Tests screen. Press the "ENET" soft key to display the Ethernet Card Parameters screen:

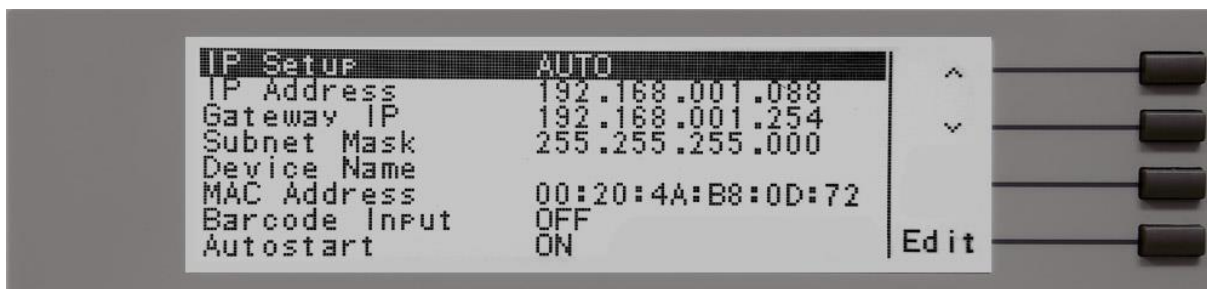

IP Setup

Highlight the IP Setup parameter using the “^, v” soft keys. When the IP Setup parameter is highlighted, press the “Edit” soft key.

IP Setup is used to determine how the HypotULTRA III will request an IP address from the server to which it is connected. When AUTO is selected, the HypotULTRA III will attempt to automatically request an IP Address from the server upon power up. To resolve the IP Address automatically, the HypotULTRA III will use DHCP or BOOTP protocols. When MANUAL is selected, the HypotULTRA III will request a specific IP Address from the server. The IP Address that will be requested must be entered in the subsequent IP Address parameter field.

Use the “Change” soft key to select how you would like the HypotULTRA III to resolve an IP address. Press the ENTER key to accept the new setting or the EXIT key to cancel and return to the original setting.

IP Address

Highlight the IP Address parameter using the “^, v” soft keys. When the IP Address parameter is highlighted, press the “Edit” soft key.

A specific IP Address must be entered into this field if the IP Setup parameter is configured to MANUAL. Enter the IP Address that you wish using the numeric keypad. The IP Address must be entered in the following format: XXX.XXX.XXX.XXX. A valid IP Address must be entered. Users may not use the following IP Addresses:

255.255.255.255
000.000.000.000

Enter the preceding IP Addresses will cause the following error message to be displayed:

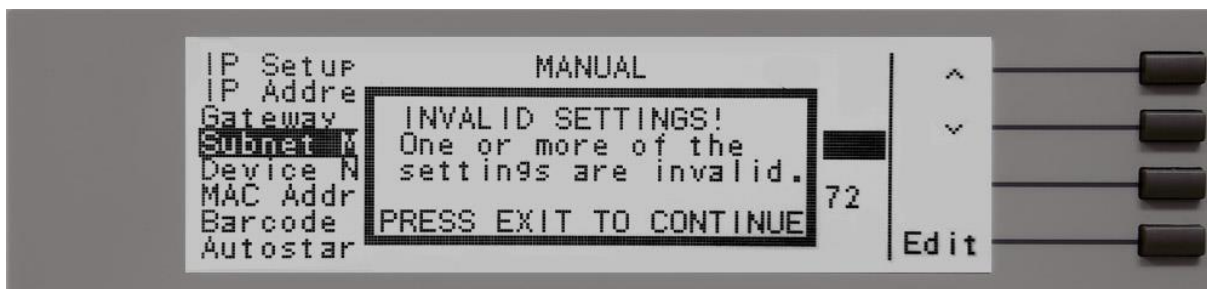

Press the EXIT key to save the new settings. If the IP Setup parameter is set to AUTO, you do not need to enter an IP Address manually.

Gateway IP

Highlight the Gateway IP parameter using the “ ^, v ” soft keys. When the Gateway IP parameter is highlighted, press the “Edit” soft key.

A specific Gateway IP must be entered into this field if the IP Setup parameter is configured to MANUAL. Enter the Gateway IP using the numeric keypad. The Gateway IP must be entered in the following format: XXX.XXX.XXX.XXX.

Press the ENTER key to save the new settings. If the IP Setup parameter is set to AUTO, you do not need to enter a Gateway IP manually.

Subnet Mask

Highlight the Subnet Mask parameter using the “ ^, v ” soft keys. When the Subnet Mask parameter is highlighted, press the “Edit” soft key.

A specific Subnet Mask must be entered into this field if the IP Setup parameter is configured to MANUAL. Enter the Subnet Mask using the numeric keypad. The Subnet Mask must be entered in the following format: XXX.XXX.XXX.XXX. If an invalid Subnet Mask is entered the following error message will be displayed:

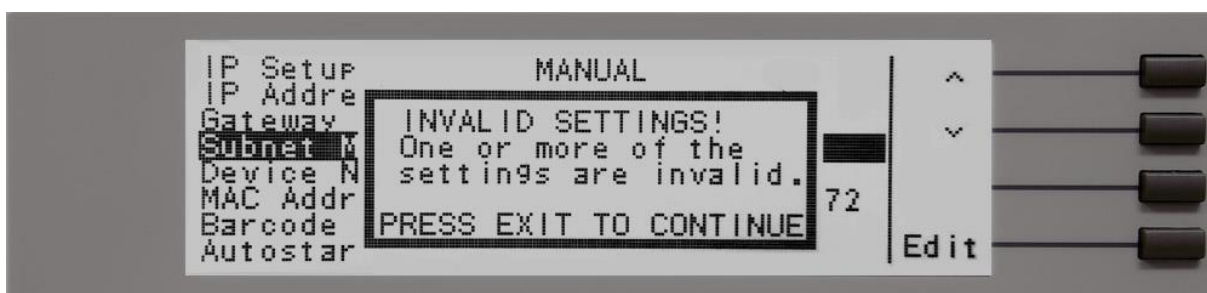

Press the ENTER key to save the new settings. If the IP Setup parameter is set to AUTO, you do not need to enter a Subnet Mask manually.

Device Name

Highlight the Device Name parameter using the “ ^, v ” soft keys. When the Device Name parameter is highlighted, press the “Edit” soft key.

The Device Name screen will appear as follows:



From this screen you may enter a Device Name for the HypotULTRA III. The Device Name is used to identify the HypotULTRA III on your server and may be used in place of a dedicated IP Address. Use the arrow keys to highlight a letter and press the “Select” soft key to select the highlighted letter. The Device Name may be a maximum of eight characters and MUST start with a letter. If the Device Name does not start with a letter the following error message will be displayed:

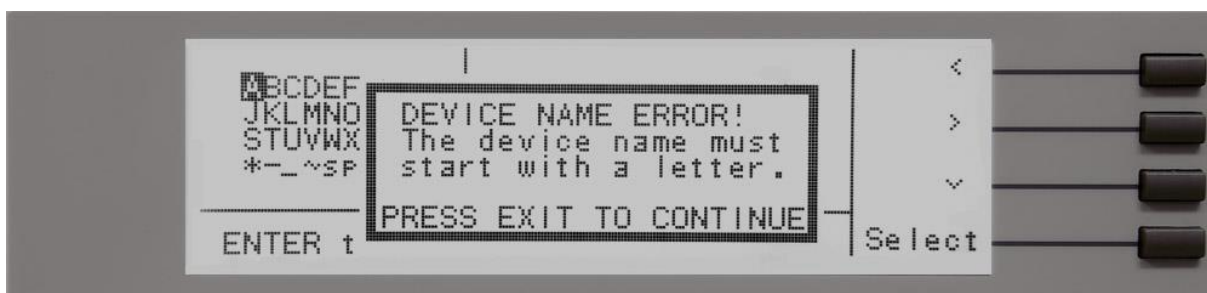

When the Device Name has been entered, press the ENTER key to save the new settings. The Device Name parameter is only active when the IP Setup is set to AUTO.

MAC Address

View the MAC address of the Ethernet Card here. This parameter is not adjustable.

Barcode I/P

Highlight the Barcode I/P parameter using the “^, v” soft keys. When the Barcode I/P parameter is highlighted, press the “Edit” soft key.

The Barcode I/P parameter can be set to SERIAL#, PRODUCT#, SER/PROD, OFF or RUN FILE. When the setting is SERIAL#, PRODUCT# or SER/PROD, the user can scan barcodes in the Perform Tests screen before the test is started. When a barcode is scanned, one of the following messages will appear on the display.

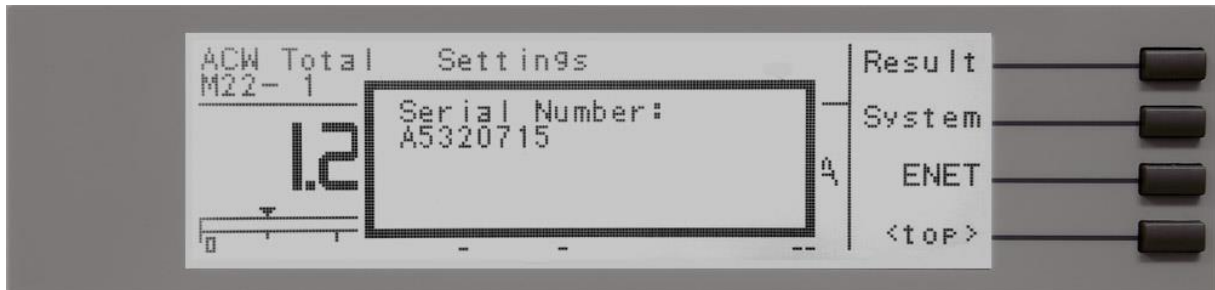

After the barcodes are scanned, press TEST to initiate the test sequence. Pressing RESET will abort the TEST sequence.

The Ethernet Card permits re-scanning of barcodes if the previously scanned barcode was incorrect. Re-scanning is only available in the SERIAL#, PRODUCT# and SER/PROD modes. If the user decides to re-scan barcodes when the Barcode I/P setting is set to SER/PROD, the Ethernet Card will first replace the data in the Serial Number field, and if the user re-scans another barcode, the Ethernet Card will replace the data in the Product Number field.

The RUN FILE selection gives the user the ability to automatically load and execute a test file based on what barcode is scanned from the Perform Tests screen. In order for this feature to work, the user must name the desired test file with the exact alphanumeric code that is on the product's barcode label. For example, if Product A has barcode "123456789", then the test file that the user would like to run when testing Product A should be named "123456789". When the product's barcode is scanned, the HypotULTRA III will immediately execute the test associated with that barcode. The test file name is limited to 10 characters. However, if the user names a test file with the maximum 10 characters, this function will still initiate a test when a product's barcode begins with those first 10 characters even if the barcode has more than 10 characters.

WARNING

Using the RUN FILE feature will enable the instrument's output once the barcode is scanned. Do not touch the DUT at any time when using this feature in order to avoid potential shock or serious injury.

When using a barcode scanner, the HypotULTRA III's responses to the TD? and RD x? commands will differ slightly from an OMNIA with the standard RS-232 interface. For all types of tests (ACW, DCW, IR, CONT) two fields are added to the end of the standard response when the Barcode I/P setting is set to SERIAL#, PRODUCT# or SER/PROD. The first field contains the Serial Number information and the second field contains the Product Number information. Both fields are included regardless of which of these three modes are selected. The Ethernet Card will substitute a "0" for the field if it is not applicable to the setting. For example, if a user had their Barcode I/P setting set to SERIAL#, and scanned a Serial Number with the value "123456789", the TD? response for an ACW test could be:

```
01,ACW,Pass,1.24,1.000,0.900,1.0,123456789,0
```

Note that there is a "0" in the Product Number field because the Barcode I/P setting is SERIAL#.

When the Barcode I/P setting is RUN FILE or OFF, these fields are not included in the TD? and RD x? responses.

Use the "Change" soft key to select the Barcode I/P. Press the ENTER key to accept the new setting or the EXIT key to cancel and return to the original setting.

Autostart

Highlight the Autostart parameter using the " ^, v " soft keys. When the Autostart parameter is highlighted, press the "Edit" soft key.

When Autostart is enabled, the test will execute as follows:

If the Barcode I/P is set to PRODUCT#, scan the barcode once to input it into the HypotULTRA III. The HypotULTRA III will then search for a test file name that matches the product number barcode string. If the HypotULTRA III finds a match, it will load the file into RAM. When the same product number barcode is scanned a second time, the test will be executed automatically. If HypotULTRA III does not find a file name that matches the barcode string, the unit will beep – notifying the user that it did not find a matching file name. The test file name is limited to 10 characters. However, if the user names a test file with the maximum 10 characters, this function will still load a test file if the first 10 characters of the product number match the file name.

If the Barcode I/P is set to SER/PROD, scan the serial number once to input it into the

HypotULTRA III. Next, scan the product number. From this point, HypotULTRA III will operate the same as when the Barcode I/P setting is set to PRODUCT#.

The Autostart feature will not work with the SERIAL# setting.

WARNING

WARNING

The Autostart feature will enable the instrument's output once the product number barcode is scanned a second time when in the PRODUCT# and SER/PROD modes. Do not touch the DUT at any time when using this feature in order to avoid potential shock or serious injury.

Use the "Change" soft key to select the Autostart setting. Press the ENTER key to accept the new setting or the EXIT key to cancel and return to the original setting.

Ethernet Card Settings Commands and Companion Queries

COMMAND	NAME	VALUE
SIM {1 0} SIM?	Set IP Mode	1=Manual, 0=Auto (DHCP/BOOTP)
SIA <value> SIA?	Set IP Address	Dotted decimal form. Ex. 192.168.1.50
SGA <value> SGA?	Set Gateway IP Address	Dotted decimal form
SSM <value> SSM?	Set Subnet Mask	Dotted decimal form
SDN <value> SDN?	Set Device Name	8 character max, must start with a letter
MAC?	MAC Address Query	Example response: 00:20:4A:8B:B4:30
SBI {4 3 2 1 0} SBI?	Set Barcode Input	0=Off, 1=Serial# and Product#, 2=Serial# Only, 3=Product# Only, 4=Run File
SAS {1 0} SAS?	Set Autostart	1=On, 0=Off

Communication Considerations

- All of the above commands (excluding the query commands) will respond with the 06 hex (6 decimal) Acknowledge (ACK) ASCII control code if the transfer was recognized by the instrument.
- If there was an error with the command string, the instrument will respond with 15 hex (21 decimal), the Not Acknowledge (NAK) ASCII control code.
- However, the presence of this response does not mean that the instrument (in the case of these commands only) completed the command. These commands require a restarting of the hardware that controls the Ethernet Protocols. Because of this, the user must wait before the Ethernet Card will respond to another command. See the table below for the approximate wait

times necessary after one of the commands in the table is sent. In addition, the current socket connection between the user's terminal and the Ethernet Card is no longer valid, and the user will need to close their current connection and establish a new one.

Ethernet Card Settings Command Wait Times

IP MODE	COMMAND	WAIT TIME AFTER COMMAND IS SENT*
Manual	SIA, SGA, SSM	8 seconds
	SIM 0	14 seconds
Auto	SDN	14 seconds
	SIM 1	8 seconds

*Wait times are approximate and can vary based on the user's network.

17 Data Storage Card

This option gives the user capabilities for serial communication, barcode scanning, and saving test results onto a USB Flash memory drive.

The Data Storage Card has three input/output ports.

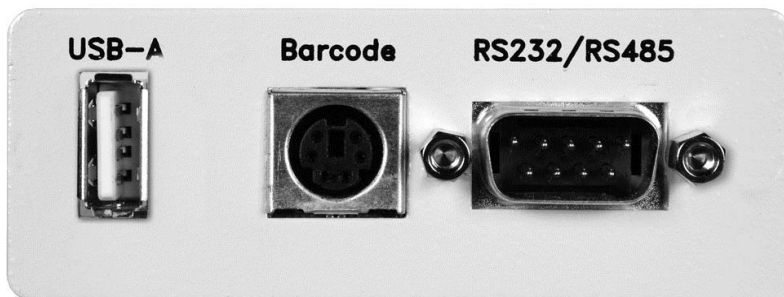

The USB-A port is used for the connection of the USB Flash memory drive.

- **NOTE:** Please use the USB Flash memory drive that was supplied with the unit. Proper file transfer can only be guaranteed with the use of this drive.

The port labeled "Barcode" is a PS/2-type connector that is used for the connection of a barcode scanner. The 9-pin D-type subminiature connector labeled "RS232/RS485" is for the connection of the HypotULTRA III to an RS232 or RS485 communication bus. To configure all of the features of the Data Storage Card, use the Data Card Settings menu shown below:



To navigate to the Data Card Settings menu, select the <more> soft key from the Perform Tests screen. Then select the “DCard” soft key. A brief description of the settings follows:

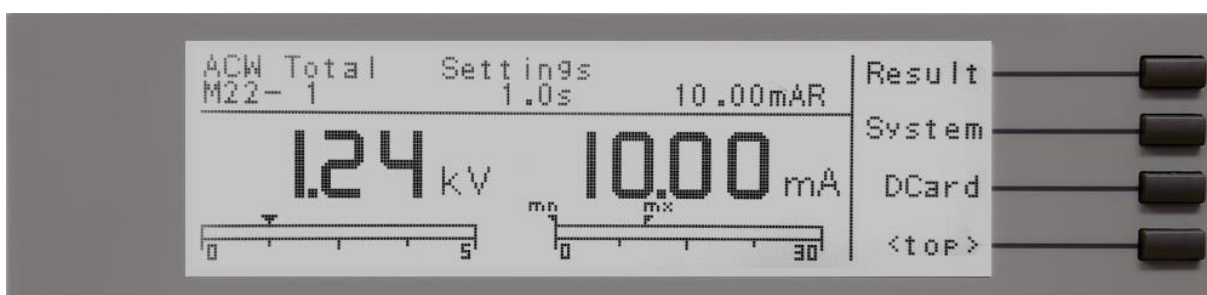

Results Limit

Highlight the Results Limit parameter using the “ \wedge , \vee ” soft keys. When the Results Limit parameter is highlighted, press the “Edit” soft key.

The Results Limit allows the user to receive an alert message on the display of the HypotULTRA III when the total number of results saved on the Data Storage Card’s internal Flash memory has exceeded the predefined limit. Use the numeric keypad to set this value from the default value of “0” (disables the function) to 100,000. Press the ENTER key to accept the new setting or the EXIT key to cancel and return to the original setting. At the conclusion of a test file, if the total results on the internal Flash memory exceed the Results Limit, the following message will display:



The message gives two options: Pressing Enter will clear the message and display it again at the end of the next test file execution. Pressing Exit will clear the message and not display it again unless the unit is re-booted, or the user deletes all previous results and the total results are exceeded once more.

Time Limit

Highlight the Time Limit parameter using the “ ^, v ” soft keys. When the Time Limit parameter is highlighted, press the “Edit” soft key.

The Time Limit allows the user to receive an alert message on the display of the HypotULTRA III when any of the results saved on the Data Storage Card’s internal Flash memory are older than the predefined setting. Use the numeric keypad to set this value from a default value of “0 days” (function is disabled) to 99 days. Press the ENTER key to accept the new setting or the EXIT key to cancel and return to the original setting. When the Time Limit is exceeded the following message will appear on the HypotULTRA III’s display:

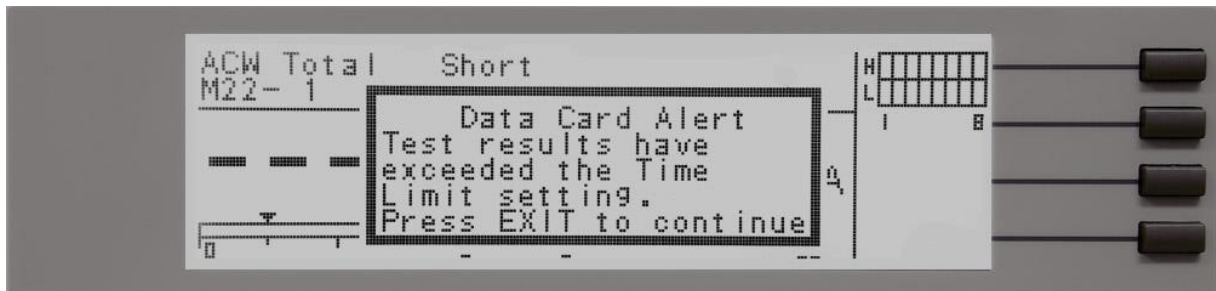

By pressing the EXIT soft key, the message will be cleared and it won’t appear again until the unit is re-booted or the Time Limit setting is set to a different value.

RS485 Address

This setting specifies the RS485 address of the Data Storage Card if the user intends to use the unit in an RS485 network. This address can be set from 1-99. For more information on this interface, see the Serial Port description below.

Test Result

Highlight the Test Result parameter using the “ ^, v ” soft keys. When the Test Result parameter is highlighted, press the “Edit” soft key.

The Test Result setting determines which type of test result is automatically saved to the Data Storage Card. The possible settings are Pass, Fail, All or None. If the Test Result setting is set to Pass, the Data Storage Card will only save results that resulted in a Pass. If the Test Result setting is set to Fail, the Data Storage Card will only save results that resulted in a Fail. Setting the Test Result setting to All will have the Data Storage Card record all results (pass or fail). If the Test Result setting is set to None, no test result (pass or fail) will be saved to the Data Storage Card’s internal memory.

Use the “Change” soft key to select the Test Result setting. Press the ENTER key to accept the new setting or the EXIT key to cancel and return to the original setting.

Serial Port

Highlight the Serial Port parameter using the “ ^, v ” soft keys. When the Serial Port

parameter is highlighted, press the “Edit” soft key.

Use the “Change” soft key to select the Serial Port setting. Press the ENTER key to accept the new setting or the EXIT key to cancel and return to the original setting. The serial port can be set to RS232, RS485, or OFF.

RS232 Interface

When selecting RS232, the protocol for interfacing and communicating with a PC can be found in section 8.8. RS232 Interface of this manual.

RS485 Interface

The RS485 interface of the Data Storage Card is designed to function on a two-wire (half-duplex) RS485 network, i.e. data is received and transmitted differentially on the same pair of wires. The RS485 cabling should be configured as shown:

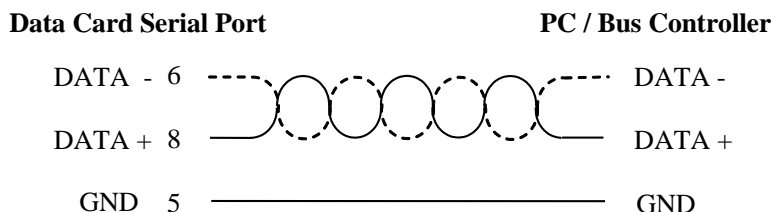

The wire used to connect the DATA signals from the Data Storage Card to the RS-485 network should be twisted pair.

Before sending a command to the RS485 enabled Data Storage Card, the unit that the command is intended for needs to be addressed. To send the address, the following format is used:

X <RS485 Address><line feed>

Note that there should be a character space between “X” and the RS485 address. After addressing the unit, the command can be sent. The instrument that was last addressed will receive all subsequent commands sent on the data bus. If the RS485 address specified is “0”, then all RS485 instruments on the bus will receive the command. The command set used for RS485 is the same as the command set for RS232. See section 7.4 for the RS232 command set.

When using the RS485 bus and sending the “0” address, the instruments will not respond with the Acknowledge (06H or 6 decimal) or Not Acknowledge (15H or 21 decimal) strings after a command is sent, and will not respond to any Query Commands.

It is also possible to combine the RS485 address and the desired instrument command all in the same string using the following format:

X <RS485 Address>;<Command><line feed>

- **NOTE:** When communicating with the HypotULTRA III using the RS485/RS232 port, results are not saved to the Data Storage Card.

Barcode I/P

Highlight the Barcode I/P parameter using the “ ^, v ” soft keys. When the Barcode I/P parameter is highlighted, press the “Edit” soft key.

The Barcode Input setting can be set to SERIAL#, PRODUCT#, SER/PROD, OFF and RUN FILE. When the setting is SERIAL#, PRODUCT# or SER/PROD the user can scan barcodes in the Perform Tests screen before the test is started. When the barcode is scanned, one of the following messages will appear on the display.

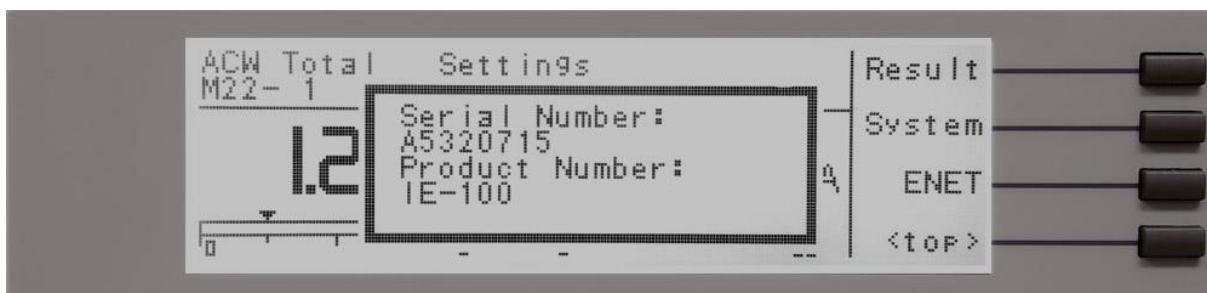
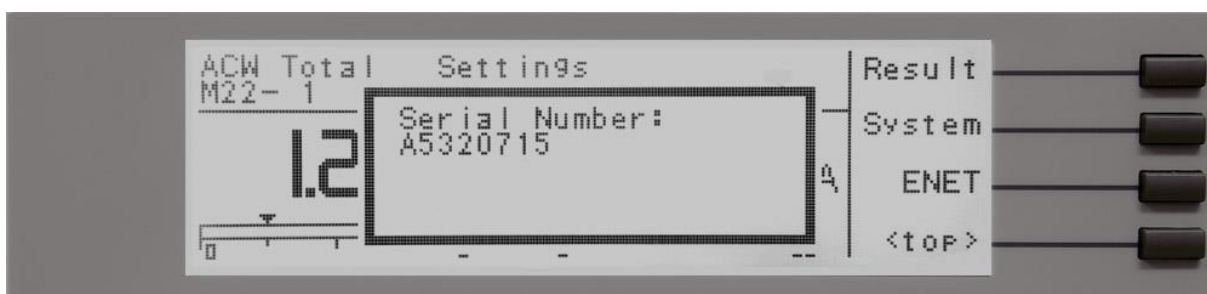

After the barcodes are scanned, pressing TEST will initiate the test sequence. Pressing RESET will abort the TEST sequence.

The Data Storage Card allows for the re-scanning of barcodes if the previously scanned barcode was incorrect. Re-scanning is available in the SERIAL#,

PRODUCT# and SER/PROD modes. Anytime before a test is initiated, the user can re-scan a barcode. If the user decides to re-scan barcodes when the Barcode I/P setting is set to SER/PROD, the Data Storage Card will first replace the data in the Serial Number field, and if the user re-scans another barcode, the Data Storage Card will replace the data in the Product Number field.

The RUN FILE selection gives the user the ability to automatically load and execute a test file based on what barcode is scanned from the Perform Tests screen.

WARNING

Using the RUN FILE feature will enable the instrument's output once the barcode is scanned. Do not touch the DUT at any time when using this feature in order to avoid potential shock or serious injury.

To completely enable this feature, the user must name the desired test file for a particular product the exact alpha-numeric code that is on the product's barcode label. For example, if Product A has barcode "123456789", then the test file that the user would like to run when testing Product A should be named "123456789". Upon scanning the barcode, the HypotULTRA III will immediately execute the test associated with that barcode. The test file name is limited to 10 characters. However, if the user names a test file with the maximum 10 characters, this function will still initiate a test when a product's barcode begins with those first 10 characters even if the barcode has more than 10 characters.

When using certain features of barcoding, the HypotULTRA III's response to the TD? and RD x? commands will differ slightly to an HypotULTRA III with the standard RS232 interface. For all types of tests (ACW, DCW, IR, CONT) two fields are added to the end of the standard response when the Barcode I/P setting is set to SERIAL#, PRODUCT# or SER/PROD. The first field contains the Serial Number information and the second field includes the Product Number information. Both fields are included regardless of which of these three modes are selected. The Data Storage Card will simply substitute a "0" for the field if it is not applicable to the setting. For example, if a user had their Barcode I/P setting set to SERIAL#, and scanned a Serial Number with the value "123456789", the TD? response for an ACW test could be:

```
01,ACW,Pass,1.24,1.000,0.900,1.0,123456789,0
```

Note that there is a "0" in the Product Number field because the Barcode I/P setting is SERIAL#.

When the Barcode I/P setting is RUN FILE or OFF, these fields are not included in the TD? and RD x? responses.

Use the "Change" soft key to select the Barcode I/P. Press the ENTER key to accept the new setting or the EXIT key to cancel and return to the original setting.

Operation

The Data Storage Card Results Menu can be viewed by pressing the “Results” soft key while in the Perform Tests screen. After doing so the following menu will be shown:

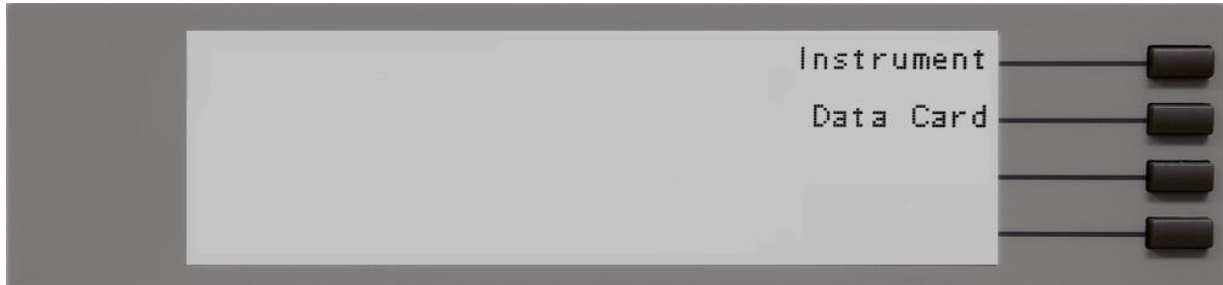

Pressing the “Instrument” soft key will display the detailed results from the previously executed test. Pressing the “Data Card” soft key will display the Data Storage Card Results menu as shown below:

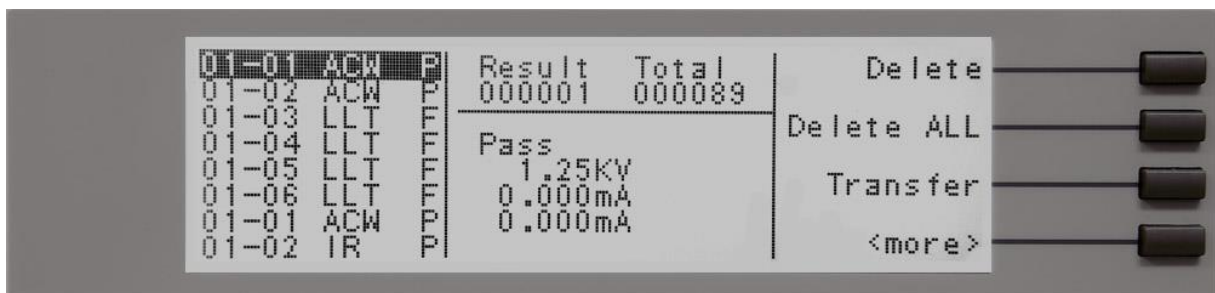

From this menu, the user can view the stored results, delete results, and transfer the results to the external USB Flash memory drive.

Press the <more> soft key to bring up the screen below:

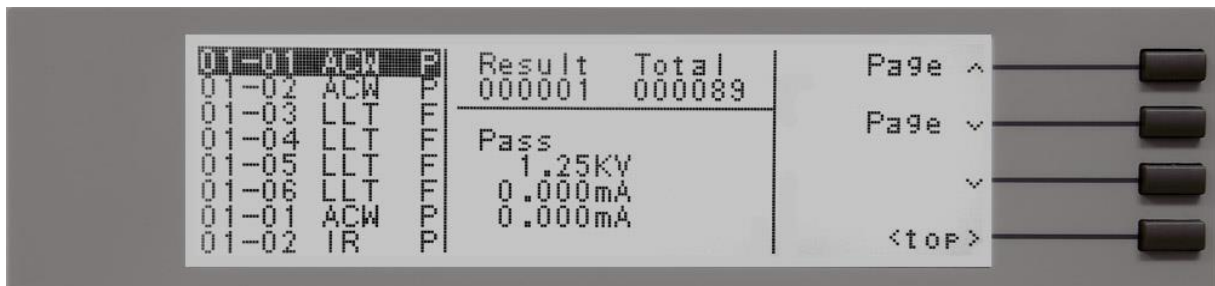

From this screen you may scroll through the test results using “Page ^” “Page v” and “v” keys. Press the <top> soft key to return to the previous menu.

The following message will display if the “Delete Result” soft key is pressed:

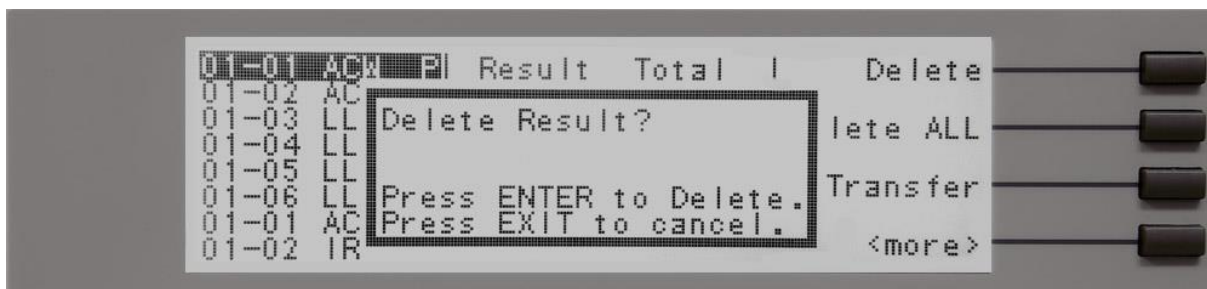

Pressing ENTER will verify that the user wants to delete all of the results on the Data Storage Card, and pressing EXIT will cancel deleting the results.

The following message will appear if the “Delete ALL” soft key is pressed:

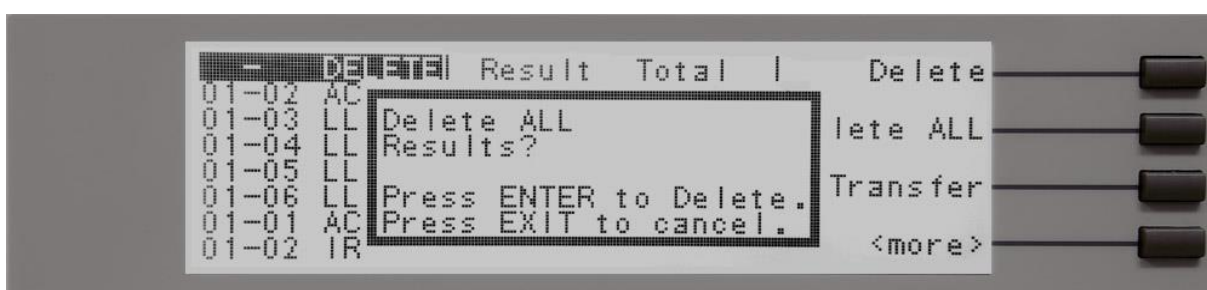

The following menu will appear if the “Transfer” soft key is pressed:



Follow the instructions on the screen in order to create a name for the file you wish to transfer. There is a limit of 8 characters for the name of the results file. Press the ENTER key when you have finished entering the file name. After pressing ENTER, you will see the following message:

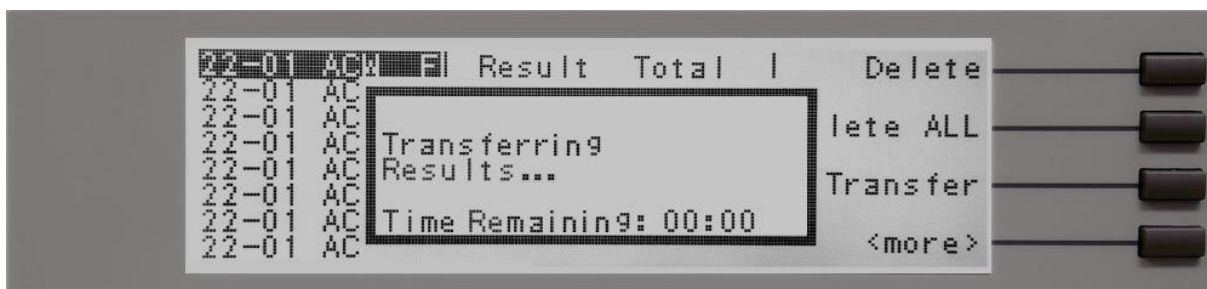

This message will appear on the screen until the Time Remaining reaches 00:00. For

each transfer, the Data Storage Card will copy all results in the internal Flash memory regardless if some or all of the results have been transferred before. During each transfer, the Data Storage Card will create a .txt file that will contain the information for all of the results. To view this .txt file, remove the USB Flash memory disk from the Data Storage Card and connect it to a PC with a USB port.

Contents of Results File

The following is an example entry in the Data Storage Card results file for an arbitrary ACW test:

00000001,06/14/06,08:26,TEST1,76xx,0120013,M01,S01,ACW,Pass,1.24KV,0.004mA,0.000mA,1.0s

The following table gives a description of each field for the above ACW test.

FIELD CONTENTS	DESCRIPTION
00000001	Test Entry in Results File
06/14/11	Date of Test
08:26	Time of Test
TEST1	Test File Name
76xx	Model Number of Testing Unit
0120013	Serial Number of Testing Unit
M01	Memory Number of Test File
S01	Step Number
ACW	Test Type
Pass	Test Result
1.24KV	Test Voltage
0.004mA	DUT Leakage Current (Total)
0.000mA	DUT Leakage Current (Real)
1.0s	Test Dwell Time

The first ten fields of the test result shown above are included in each test result regardless of the test type. The remaining entries are specific to each test type. The following table shows, in order, the information that will be included in each test type's result entry.

ACW	DCW	IR	CONT
Test Voltage	Test Voltage	Test Voltage	DUT Resistance
DUT Leakage Current (T)	DUT Leakage Current	DUT Resistance	Test Dwell Time
DUT Leakage Current (R)	Test Dwell Time	Test Delay Time	
Test Dwell Time			

- NOTE: If barcoding is used, the barcoding information will be the final entries in the results file with Serial Number being first and Product Number being second.

Other Displayed Messages

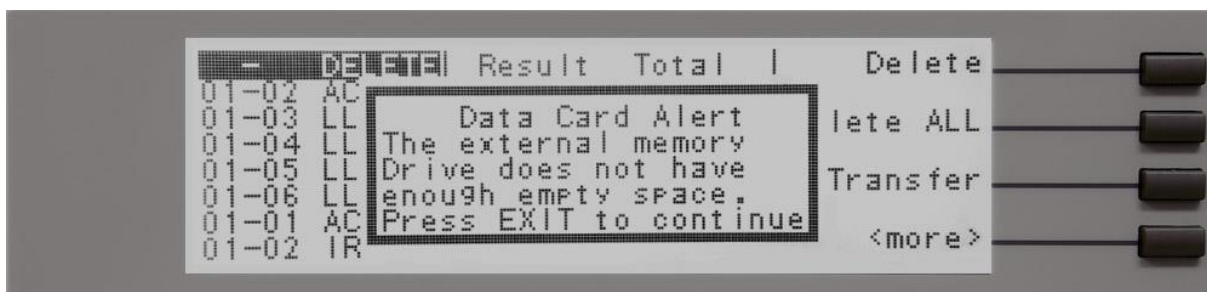

The above message occurs when the user attempts to transfer results from the Data Storage Card onto the USB Flash memory drive, but there is not enough empty space on the drive to save the file. To save the results file, the user needs to create some empty space on the USB Flash memory drive.



The above message occurs when the total results accumulated on the Data Storage Card exceeds 100,000. The HypotULTRA III will not allow any more tests to be run unless the user deletes the results currently on the Data Storage Card or changes the Test Result setting in the Data Card Settings menu to NONE. If the Test Result setting is set to NONE, the Data Storage Card will not record test results.

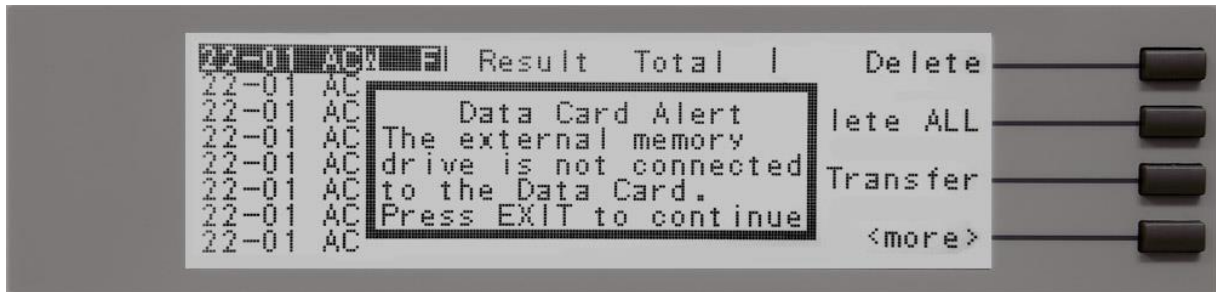

The above message occurs when the user tries to transfer results from the Data Storage Card without the USB Flash memory drive connected. To transfer results, the user needs to have the Flash memory drive connected to the Data Storage Card.

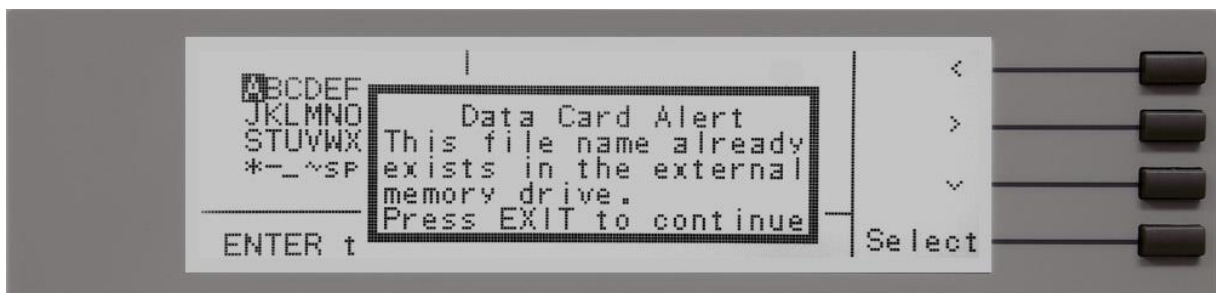

The above message appears when the user attempts to give a name to a results file that already exists on the Data Storage Card.

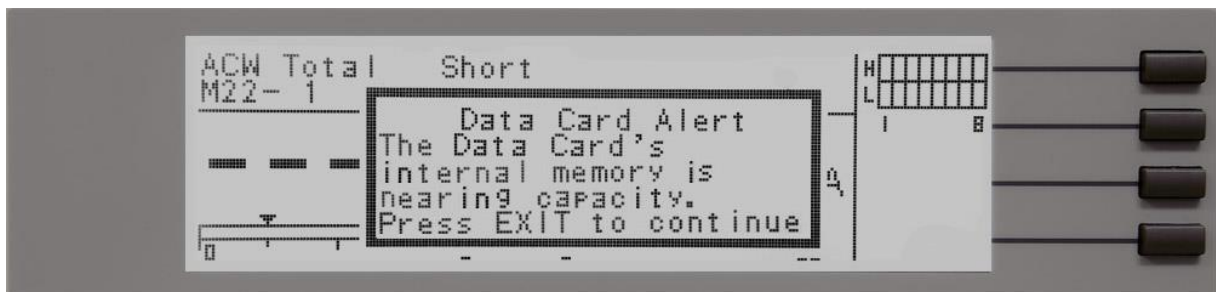

The above message appears when the total results accumulated by the Data Storage Card exceeds 99,900. This is a warning to the user that the total results are nearing the capacity of the Data Storage Card (100,000). When the total results on the Data Storage Card exceed 100,000, the Data Storage Card will cease saving results. To avoid this, the user can transfer and delete the old test results, or change the Test Result setting in the Data Card Settings menu to NONE. When the Test Result setting is set to NONE, the Data Storage Card will not record test results.

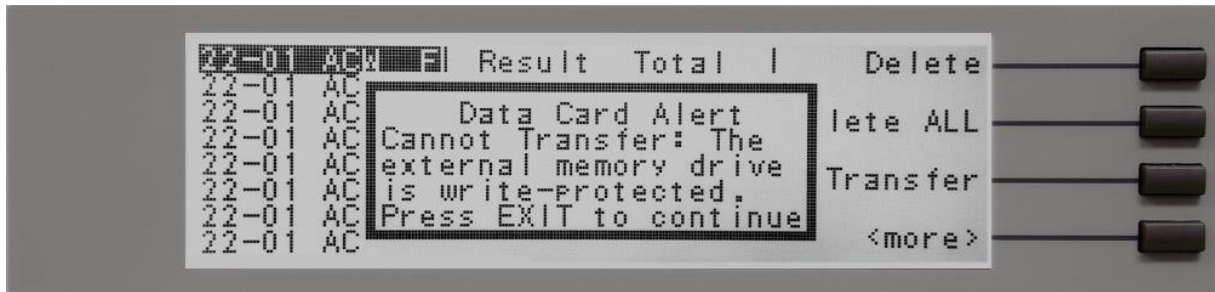

The above message appears when the USB Flash memory drive is write-protected. There are two ways to configure the memory drive as write-protected. One is to set the switch on the side of the memory drive up (towards the drive's connector). The other is to configure it through the drive's properties in Windows.

9. VERIFICATION

Verification is the process by which an instrument's failure detectors are proven to be functioning properly. Verifying the failure detection circuitry of the electrical safety tester is required by safety agencies such as CSA, UL, and TÜV.

- **NOTE:** Verification should be performed at the beginning of each day or each shift, before testing has begun.

9.1. Verification Initialization

Power up the tester. The initialization screen will appear with a message at the bottom indicating press <TEST> for verification. You now have the option to press the TEST button and activate the Verification Menu. The option to activate verification expires approximately 3 seconds after power-up. The Initialization screen will appear as follows:



9.2. Verification Menu

From the Initialization screen (first start up screen), press the TEST button. The Verification Menu will now be displayed. If you have a Model 7650, four different Verification processes may be accessed; Continuity, AC Hipot, DC Hipot, and IR. If you have a Model 7620, two different Verification processes may be accessed; Continuity and AC Hipot.



- **NOTE:** During the verification process, all Remote control output signals except the FAIL output are disabled.

9.2.1. Continuity Verification

From the Verification screen, press the “^” and “v” soft keys to select “Continuity.” Then press the “Select” soft key. An instructional prompt will now be displayed. The prompt will appear as follows:



Follow the instructions given in the prompt and then press TEST to begin the verification process.

At the end of the verification process a message will appear indicating the outcome of the process. If the instrument passes the verification (test failure, indicating the fail detectors are working properly) the RESET button will illuminate, the alarm will sound and the following message will appear:



If the instrument fails the verification (test pass, indicating the fail detectors are not working properly) the following message will appear:



9.2.2. AC Hipot Verification

From the Verification screen, press the “^” and “v” soft keys to select “AC Hipot.” Then press the “Select” soft key. An instructional prompt will now be displayed. The prompt will appear as follows:



Follow the instructions given in the prompt and then press TEST to begin the verification process.

At the end of the verification process a message will appear indicating the outcome of the process. If the instrument passes the verification (test failure, indicating the fail detectors are working properly) the RESET button will illuminate, the alarm will sound and the following message will appear:



If the instrument fails the verification (test pass, indicating the fail detectors are not working properly) the following message will appear:



9.2.3. DC Hipot Verification (Model 7650 only)

From the Verification screen, press the “^” and “v” soft keys to select “DC Hipot.” Then press the “Select” soft key. An instructional prompt will now be displayed. The prompt will appear as follows:



Follow the instructions given in the prompt and then press TEST to begin the verification process.

At the end of the verification process a message will appear indicating the outcome of the process. If the instrument passes the verification (test failure, indicating the fail detectors are working properly) the RESET button will illuminate, the alarm will sound and the following message will appear:



If the instrument fails the verification (test pass, indicating the fail detectors are not working properly) the following message will appear:



9.2.4. IR Verification (Models 7650 only)

From the Verification screen, press the “^” and “v” soft keys to select “IR.” Then press the “Select” soft key. An instructional prompt will now be displayed. The prompt will appear as follows:



Follow the instructions given in the prompt and then press TEST to begin the verification process.

At the end of the verification process a message will appear indicating the outcome of the process. If the instrument passes the verification (test failure, indicating the fail detectors are working properly) the RESET button will illuminate, the alarm will sound and the following message will appear:



If the instrument fails the verification (test pass, indicating the fail detectors are not working properly) the following message will appear:

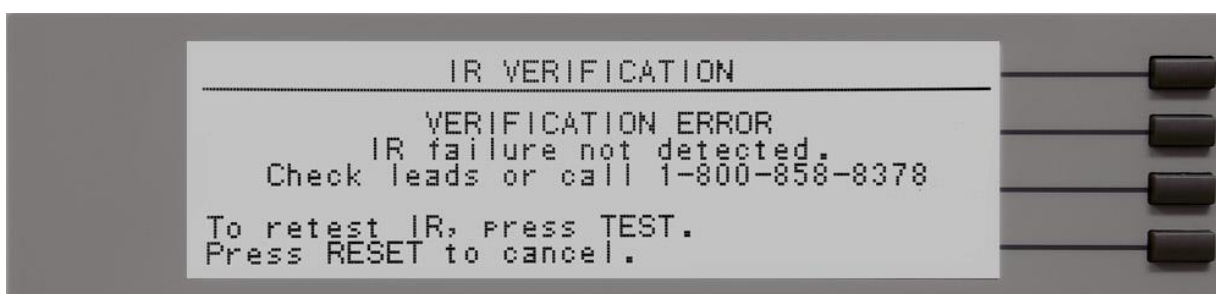

10. CALIBRATION

DID YOU KNOW?

This instrument has been fully calibrated at the factory in accordance to our published specifications and with standards traceable to the National Institute of Standards & Technology (NIST).

You will find in this manual a copy of the "Certificate of Calibration". It is recommended that you have this instrument recertified at least once per year. Associated Research, Inc. recommends you use "Calibration Standards" that are NIST traceable or traceable to agencies recognized by NIST to keep this instrument within published specifications. Unless necessary, do not recalibrate the instrument within the first 12 months.

End user metrology standards or practices may vary. These metrology standards determine the measurement uncertainty ratio of the calibration standards being used. Calibration adjustments can only be made in the Calibration mode and calibration checks or verifications can only be made while operating in Test mode.

- **NOTE:** Verification should be performed before and after calibration. Calibration effects will only be noticeable after exiting calibration mode.

10.1. Warranty Requirements

Associated Research, Inc. offers a standard one-year manufacturer's warranty. This warranty can be extended an additional four years provided that the instrument is returned each year to Associated Research, Inc. for its annual recertification. In order to be eligible for the extended warranty instruments must be returned to Associated Research, Inc. for certification service at least once every twelve months.

A return material authorization number (RMA) must be obtained from Associated Research, Inc. before returning this instrument for calibration. To obtain an RMA number or for information regarding our warranty, please contact our customer support representatives at 1-800-858-TEST (8378) or setup an RMA online at <http://www.asresearch.com/support/RMA-request.aspx>.

Required Calibration Equipment

- 0 - 5 KV AC/DC Metered Voltage Divider.
- 30 mA AC, 10 mA DC Ammeter.
- 20 Ω , 0.25 watt resistor, 250 volt.
- 200 Ω , 0.25 watt resistor, 250 volt.
- 2000 Ω , 0.25 watt resistor, 250 volt.
- 50M Ω , 0.25 watt resistor, 1000 volt.
- 500M Ω , 0.25 watt resistor, 1000 volt.
- 100K Ω , 250 watt resistor, 5000 volt.
- 1M Ω , 20 watt resistor, 5000 volt.

10.2. Calibration Initialization

Press and hold the calibration key on the rear panel with a pen, pencil, or small screwdriver while powering ON the HypotULTRA III. The HypotULTRA III enters calibration mode after the power on sequence is complete. The Initial Calibration screens will appear as follows:

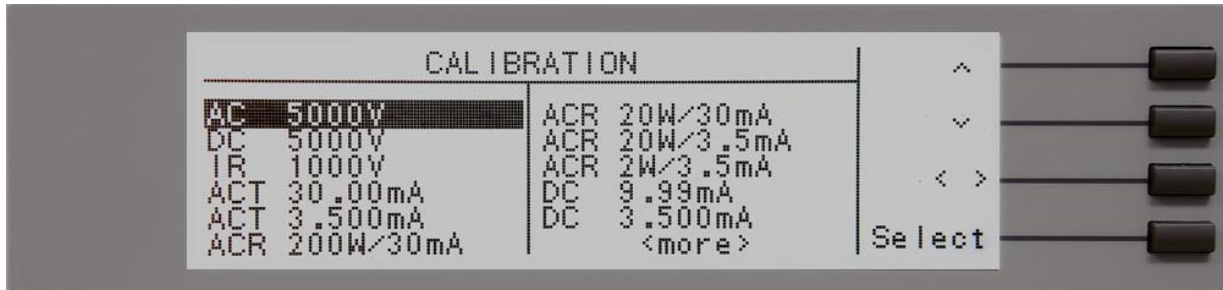

10.3. Selecting Specific Calibration Points

When the calibration is initialized, the first calibration point is automatically selected. The calibration is set up so that as each calibration point is completed the highlighted area will automatically scroll to the next calibration point.

To manually select calibration points, use the up and down arrows to scroll the highlighted area to the desired calibration point.

10.4. Calibration of Parameters

From the Calibration screens, use the arrow keys to scroll the Cursor to the parameter you wish to calibrate. Once the cursor is pointing to the parameter you wish to calibrate, press the “Select” soft key. A calibration prompt screen will now appear that describes the necessary load and connection information for the parameter being calibrated.

The following is a list of the calibration parameters and an example of the prompt screen with the details that will be displayed for each parameter (screen shown at top). Once you press TEST, the Calibration data entry screen will appear for the selected parameter (screen shown at bottom). Read the measurement from your standard and enter it using the numeric keypad. You may now store the new calibration number by pressing the ENTER key or escape by pressing the EXIT key or the RESET button.

10.4.1. Calibration of AC Hipot Voltage

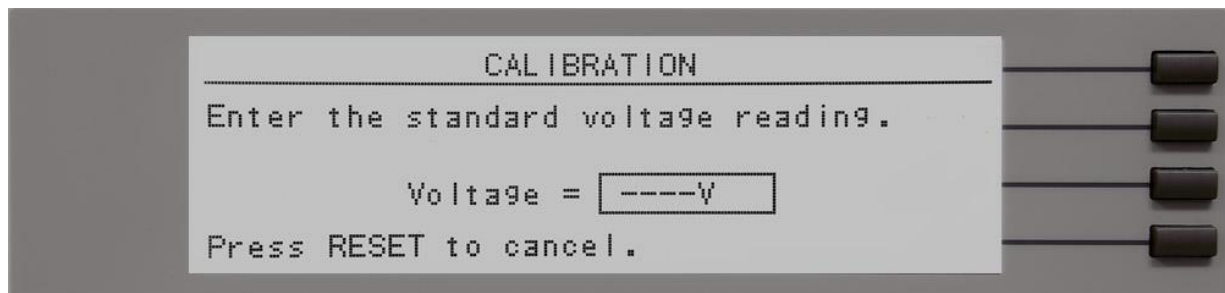
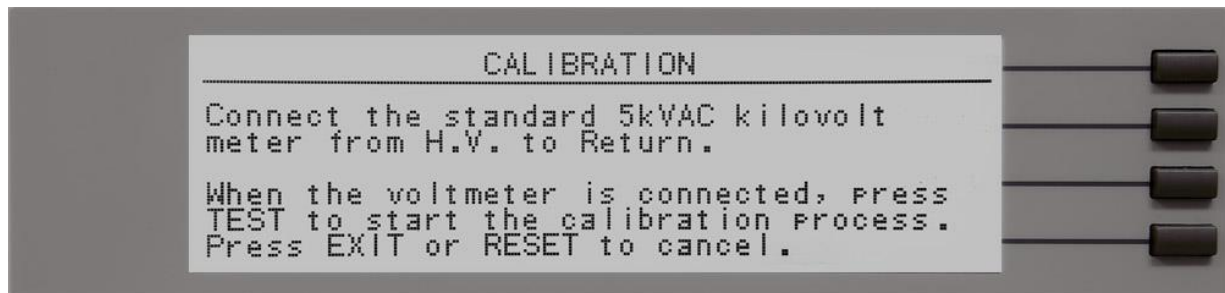

10.4.2. Calibration of DC Hipot Voltage

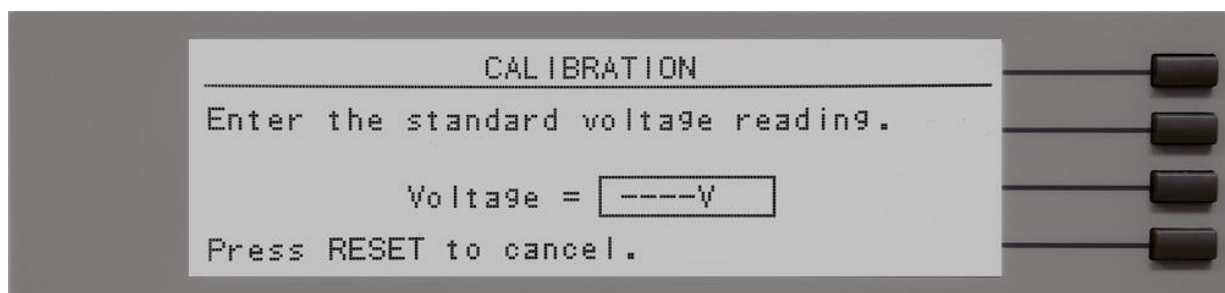
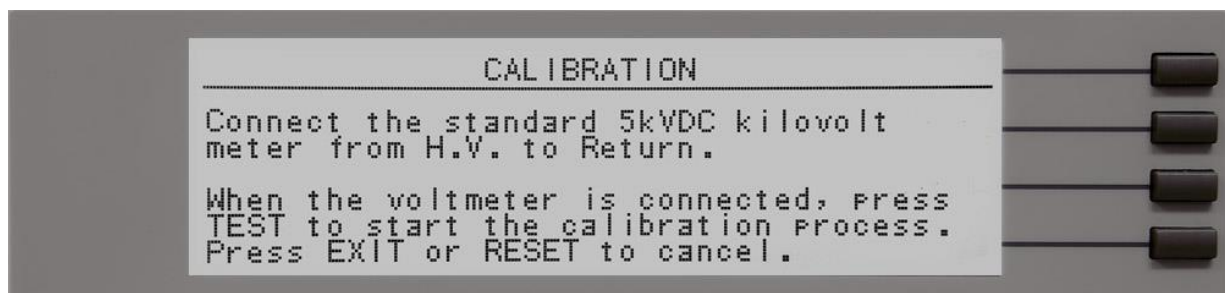

10.4.3. Calibration of IR DC Voltage

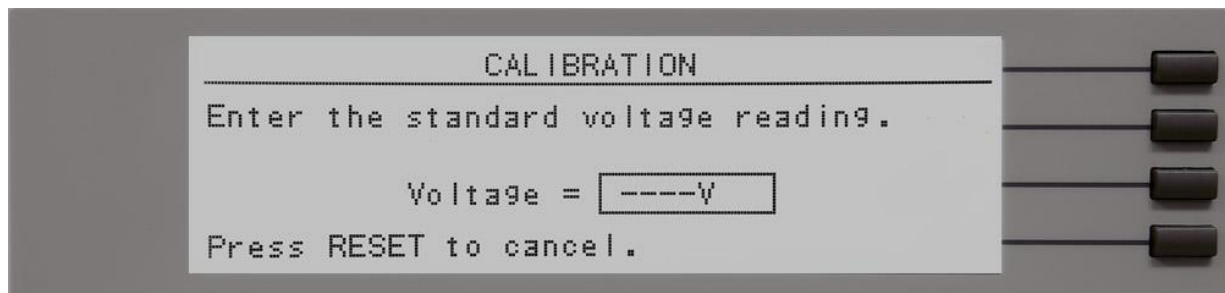
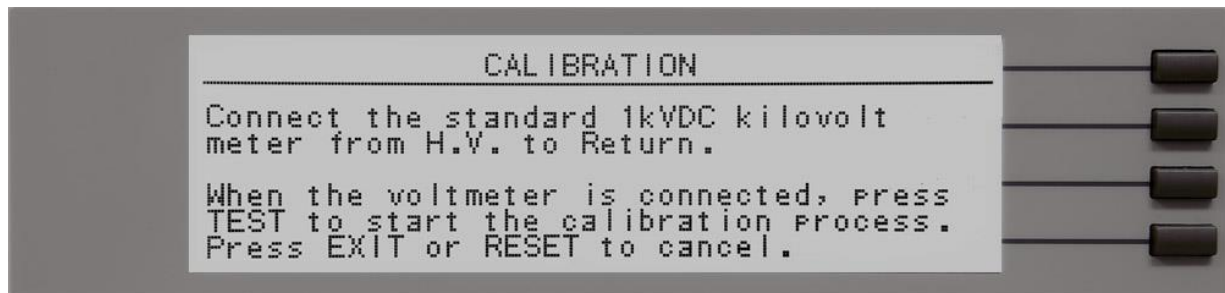

10.4.4. Calibration of 30mA AC Total Current Range

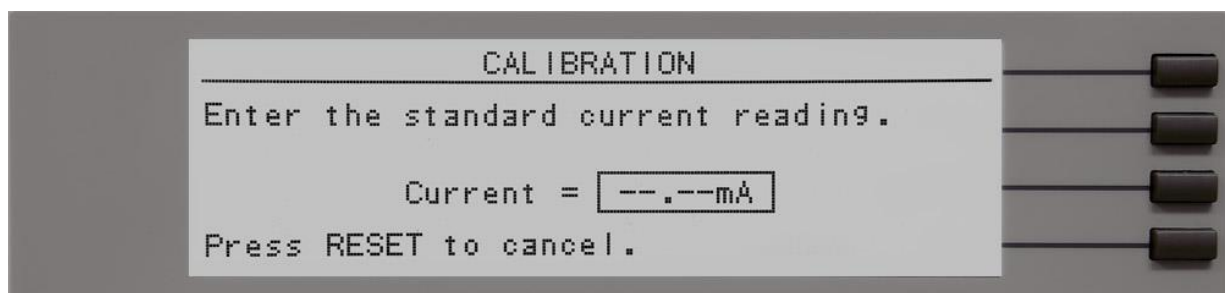
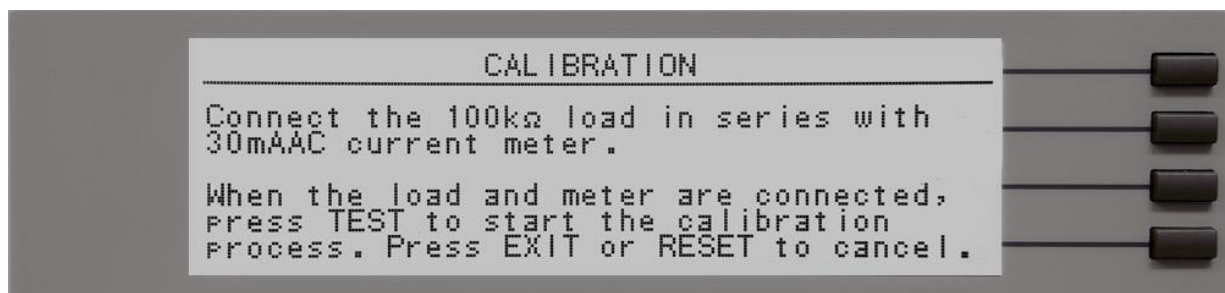

10.4.5. Calibration of 3.5mA AC Total Current Range

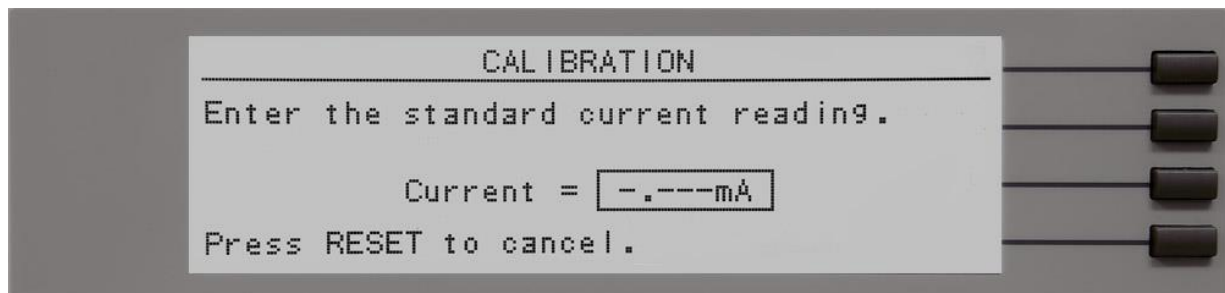
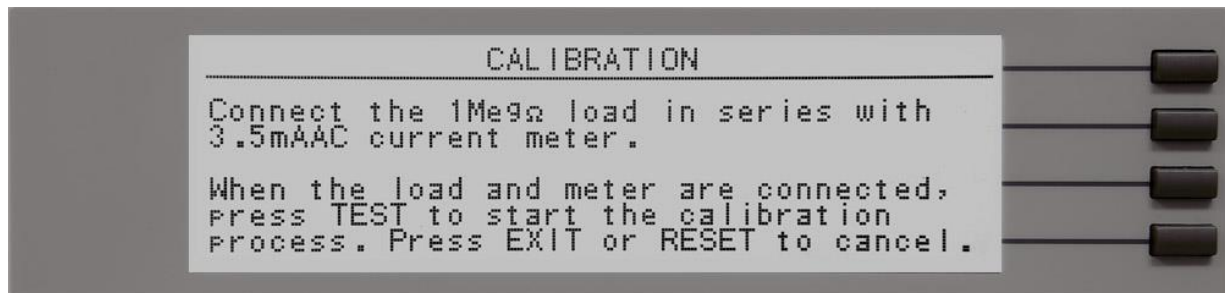

10.4.6. Calibration of 200W/30mA AC Real Current Range

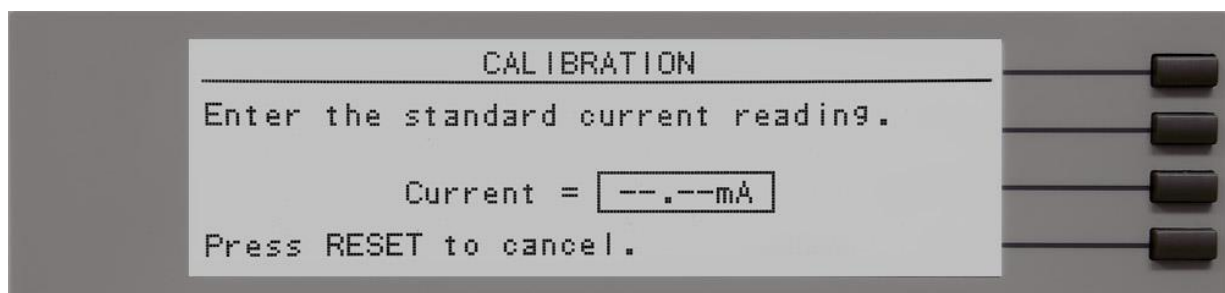
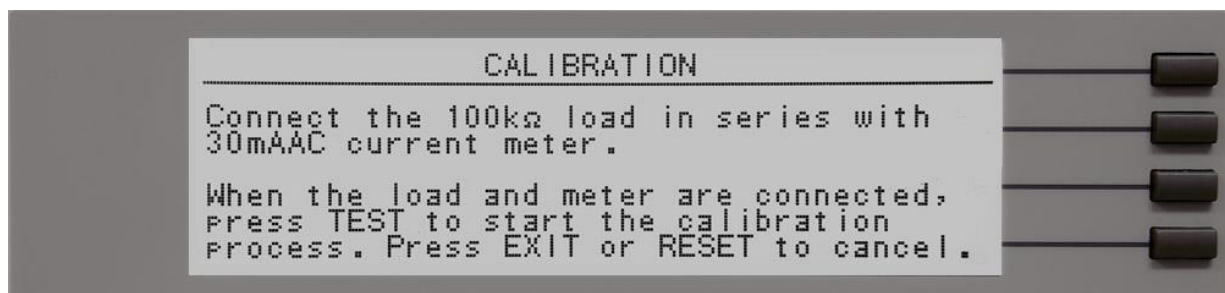

10.4.7. Calibration of 20W/30mA AC Real Current Range

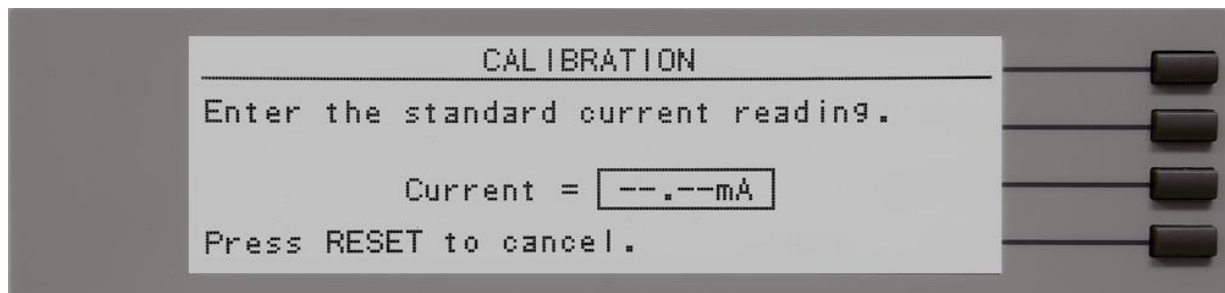
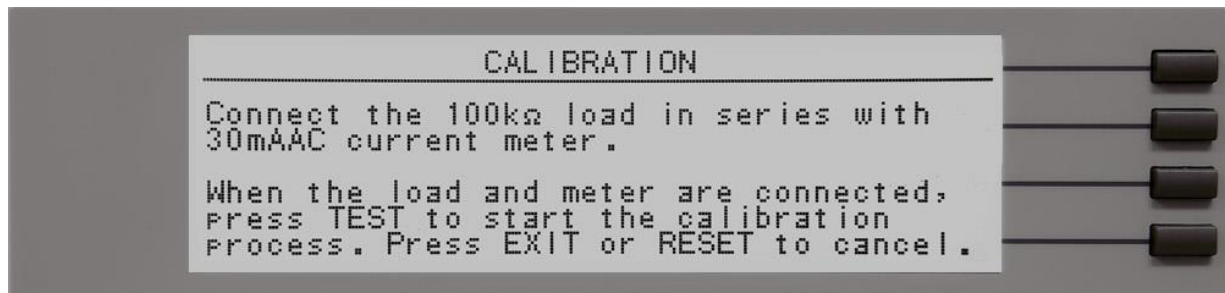

10.4.8. Calibration of 20W/3.5mA AC Real Current Range

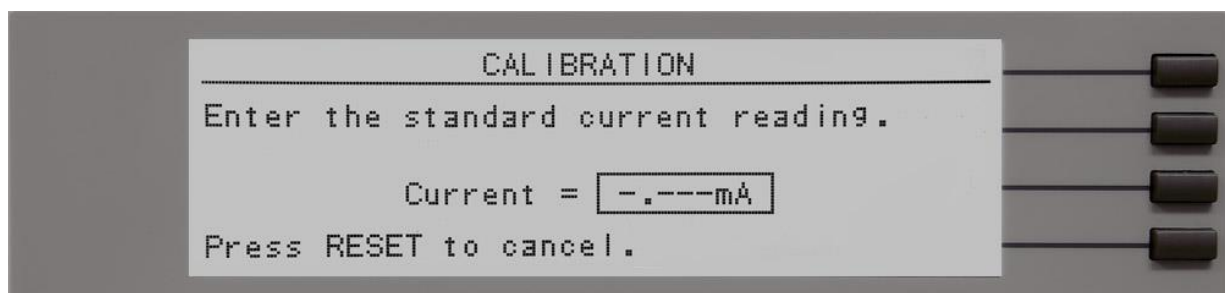
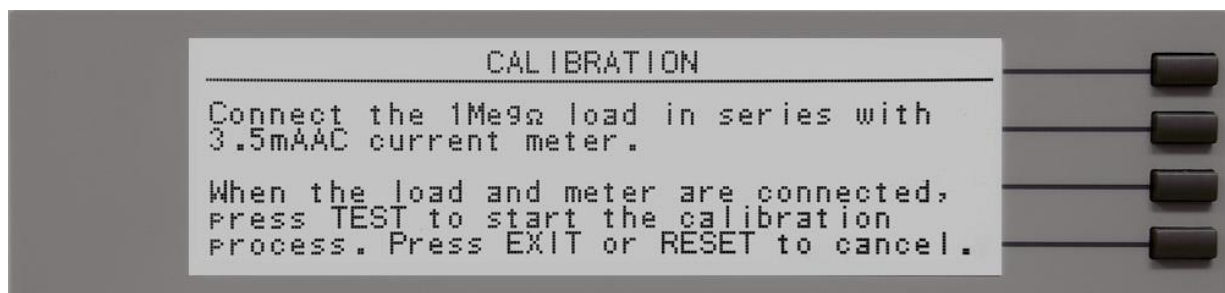

10.4.9. Calibration of 2W/3.500mA AC Real Current Range

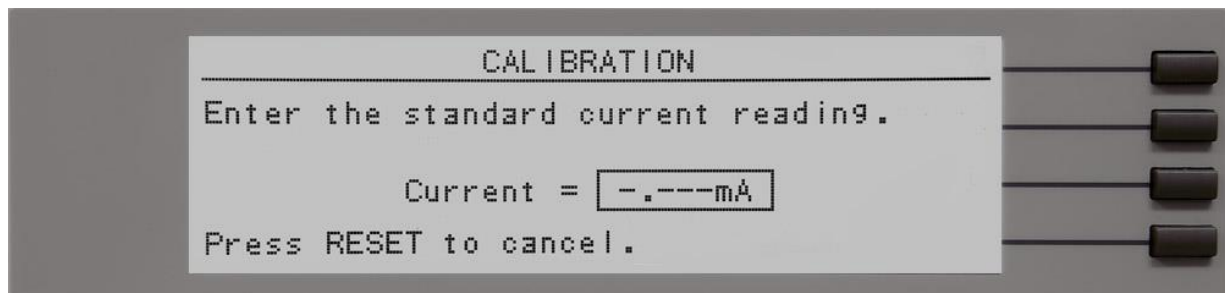
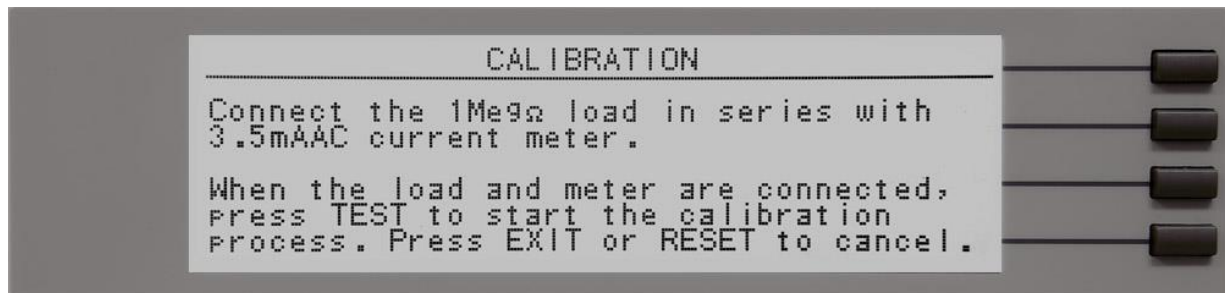

10.4.10. Calibration of 10mA DC Current Range

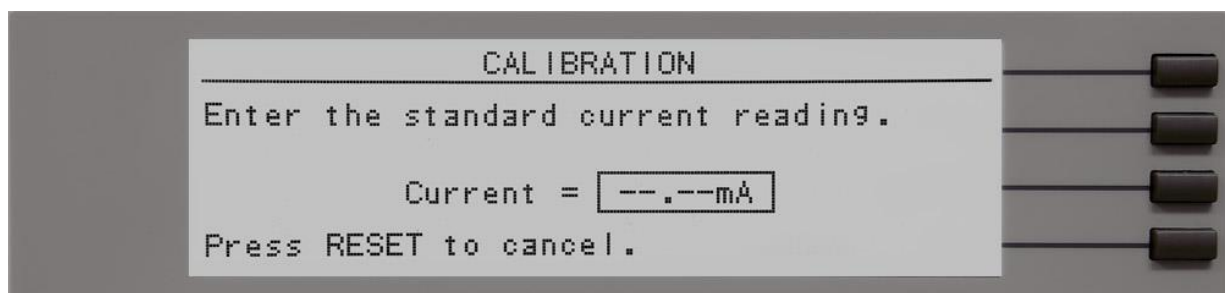
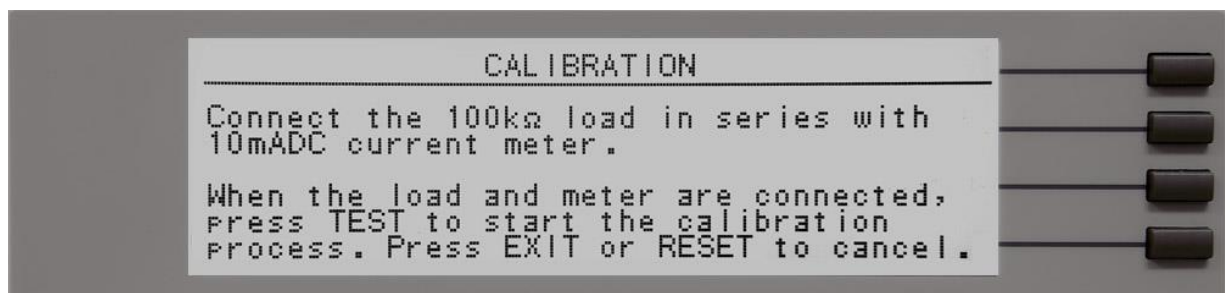

10.4.11. Calibration of 3.500mA DC Current Range

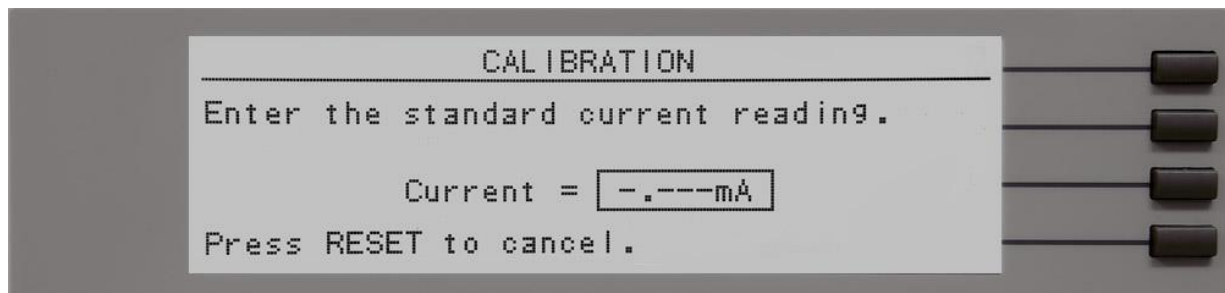
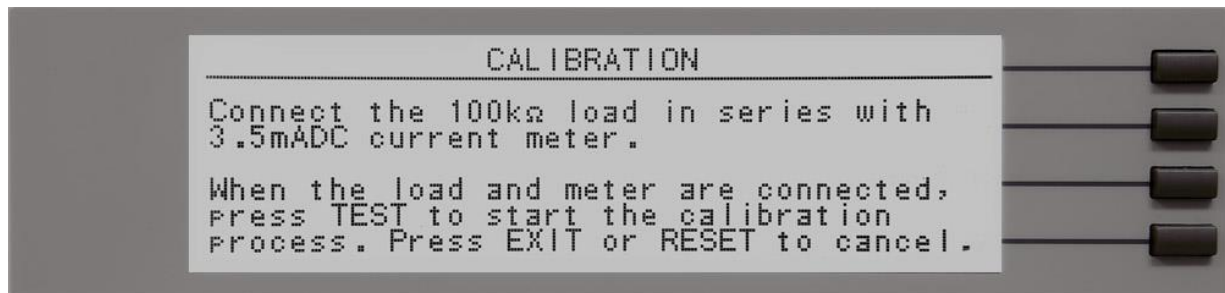

10.4.12. Calibration of 350uA DC Current Range

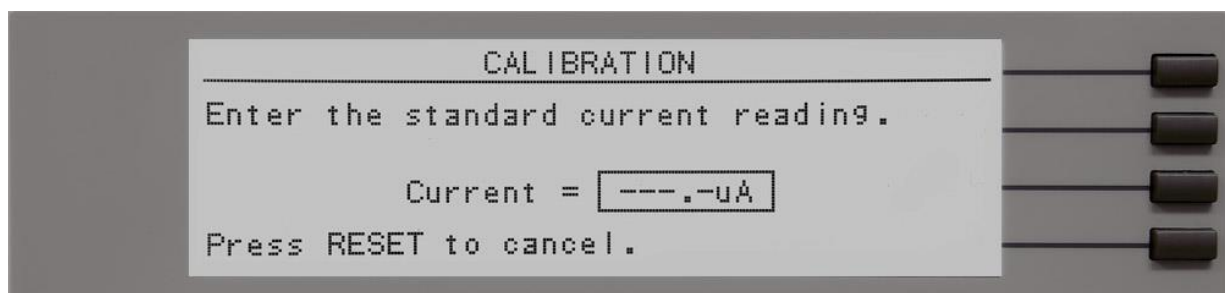
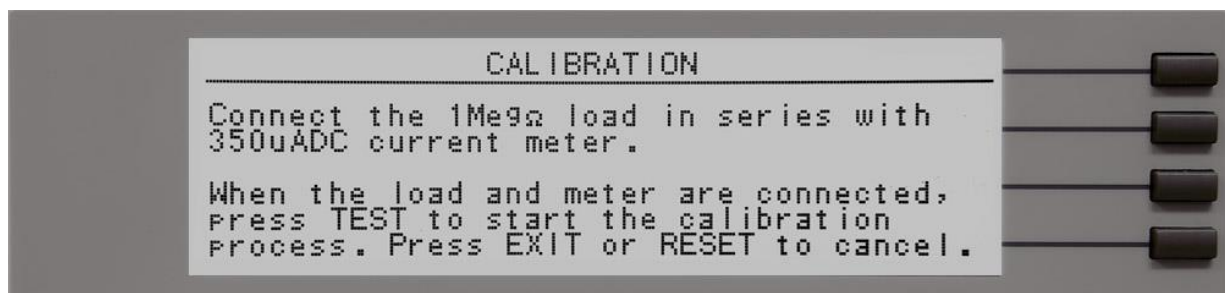

10.4.13. Calibration of 999.99M Ω IR Range

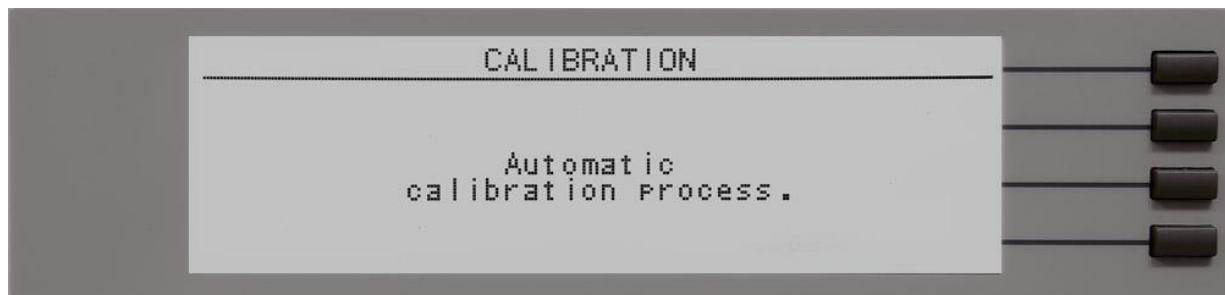
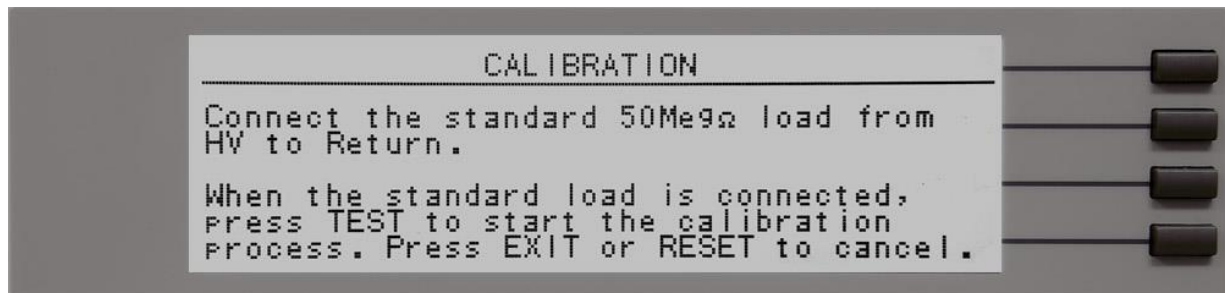

10.4.14. Calibration of 9999.9M Ω IR Range

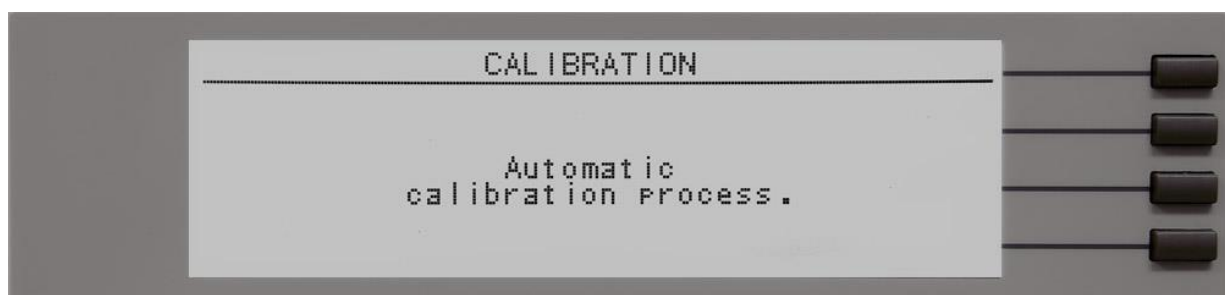
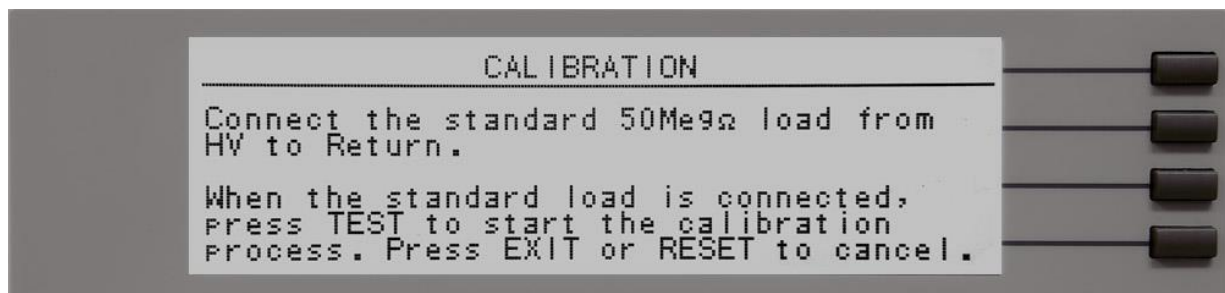

10.4.15. Calibration of 50000M Ω IR Range

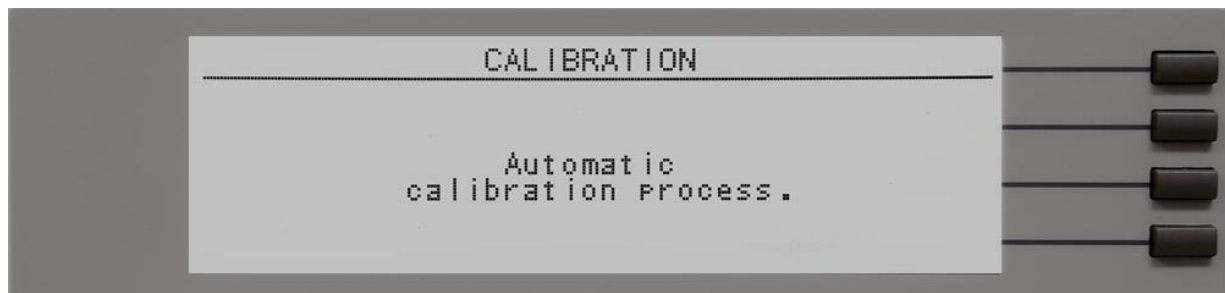
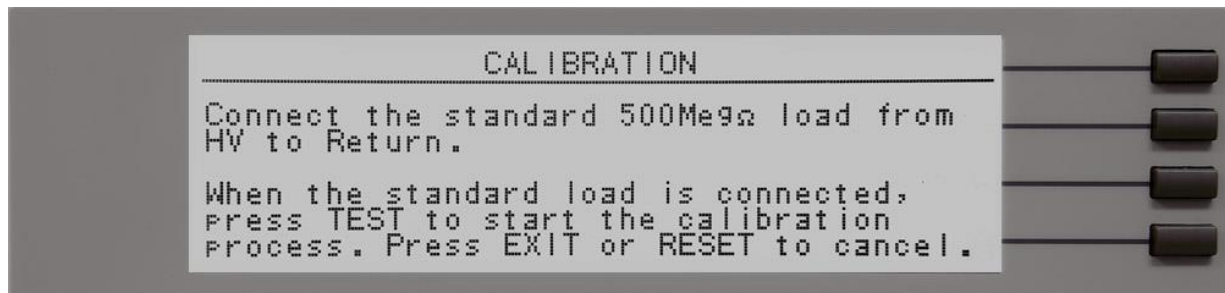

10.4.16. Calibration of DC Continuity 20 Ω

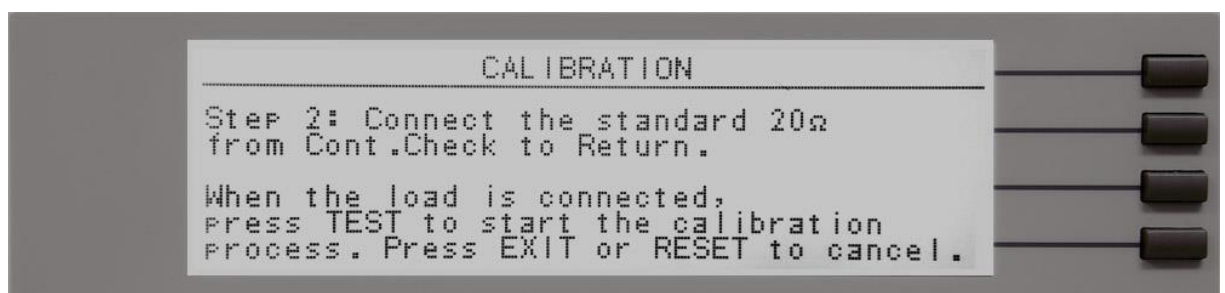
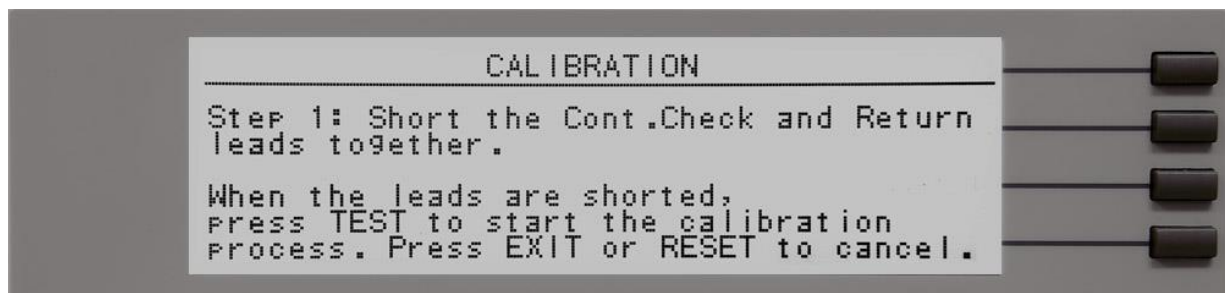

This screen will appear after both steps 1 and 2.

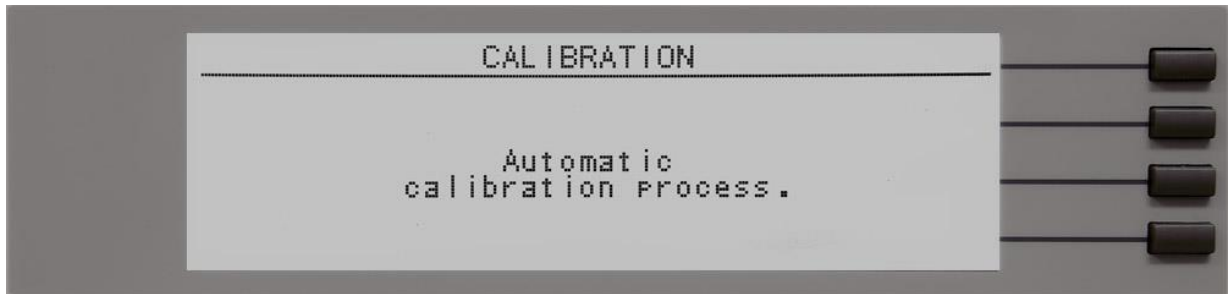

10.4.17. Calibration of DC Continuity 200Ω

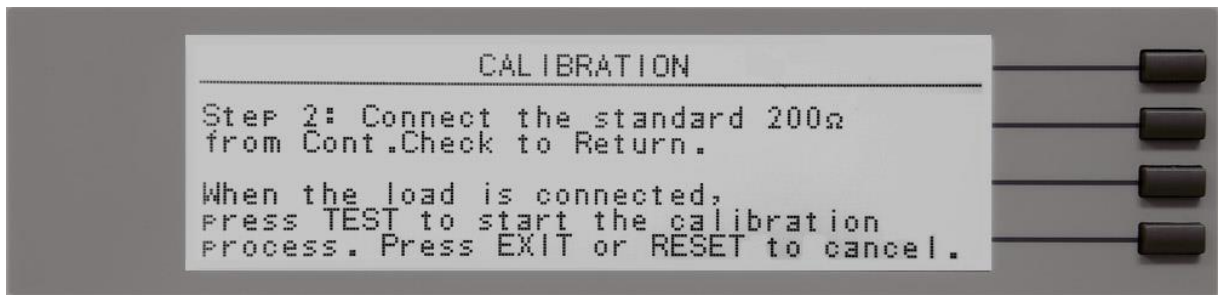
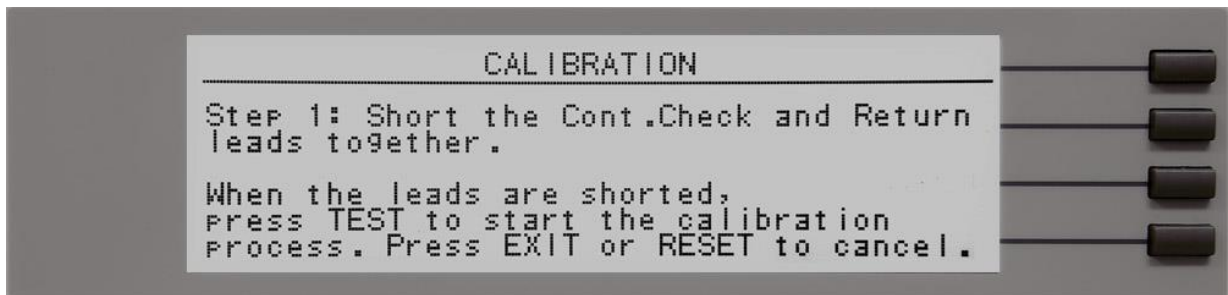

This screen will appear after both steps 1 and 2.

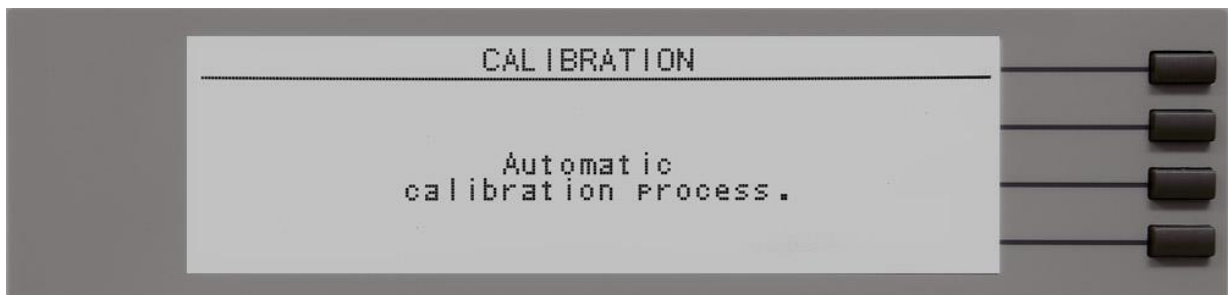

10.4.18. Calibration of DC Continuity 2000 Ω

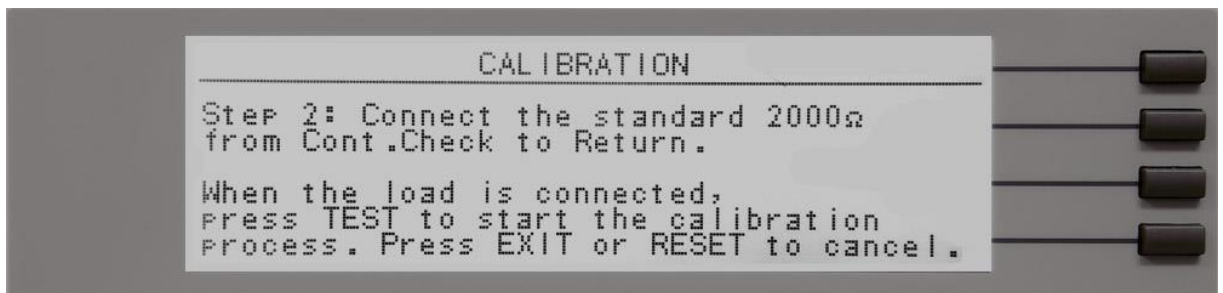
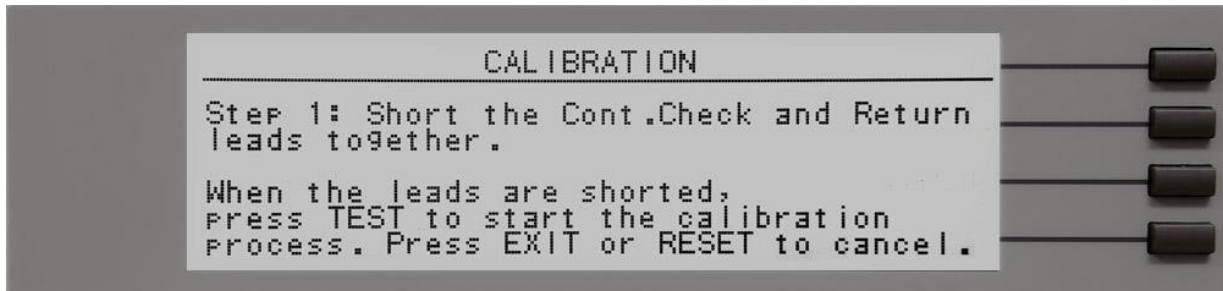

This screen will appear after both steps 1 and 2.

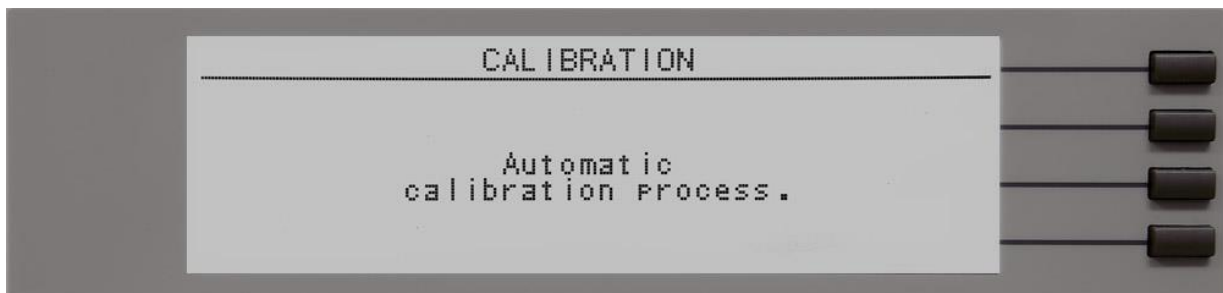

11. REPLACEMENT PARTS

Rev: J 8-21-2012 ECO 5548

Part Number	Qty.	Ref. Designator	Description
Supplied Accessories			
38794	2	-	2U Rack Mount Handle
38793	2	-	2U Rack Mount Bracket
38549	4	-	Screw for Rack Mount Handle/Bracket
38388	1	-	Fuse 4A 250V Slow Blow 20mm
04040A-08	1	-	High Voltage Cable
02100A-13	2	-	Cable Assembly Return
39066	1	-	USB Cable AB-Type 1.8m
33189	1	-	Cable Input Cordset USA
38075	1	-	Interlock Connector
36544	1	-	Adapter Box
Panel Components			
35999	1	-	Black Banana Jack
37478	2	-	High Voltage Connector
38069	1	-	Power Switch 2P 15A
37571	1	-	Earth Connector
37806	1	TEST	Test Switch Green Lighted
37807	1	RESET	Reset Switch Red Lighted
39391	1	Test/Pass	Replacement Bulb
39392	1	Reset/Fail	Replacement Bulb
38364	1	-	Fuse Holder 5 x 20 PCB Mount
38101	1	-	Feet Kit w/o Rubber Inserts
38102	4	-	Rubber Insert for Feet
38916	1	-	Graphic LCD Display
PCB Assemblies			
38394	1	CON7650	Main Control Board
38194	1	REA7500	Real Current Board
38478	1	HV7650 (7650 only)	High Voltage Control Board
38479	1	HV7650 (7620 only)	High Voltage Control Board
38390	1	AMP7650	Amplifier Board
38396	1	KEYU3	Key Board
38401	1	CSU7650	8 Channel Scanner Board
38402	1	CSU7650	4 Channel Scanner Board
39063	1	USB/RS232	USB/RS232 Interface Board
38305	1	CGP-03	GPIB Interface Board
39061	1	CPR-01	Printer Card
38801	1	USB	Data Storage Card
38819	1	38818	Ethernet Card

Part Number	Qty.	Ref. Designator	Description
Internal Components			
38235	1	IC 27	IC 29C020 EEPROM DIP
38424	1	IC 31	IC BQ3287 Real-Time Clock
38298	1	IC 40	IC ATF16V8B 20pin PLCC
38427	1	IC 41	IC 29C020 EEPROM PLCC
38428	1	IC 51	IC XA-G30 Microcontroller
38391	1	T1	Input Transformer
38393	1	T2	High Voltage Output Transformer

12. SCHEMATIC INDEX

DRAWING NUMBER	DESCRIPTION	REFERENCE DESIGNATOR	PAGES
S07650	Wiring Diagram	-	1
S38394	Main Control Board	CON7650	7
S38194	Real Current Board	REA7500	1
S38478	HV Control Board	HV7650	2
S38390	Amplifier Board	AMP7650	2
S38392	Connector Transfer Board	CNR7650	1
S38396	Keypad Board	KEYU3	1
S38401	Scanner Control Board	CSU7650	1
S37745	GPIB Interface Board	CGP-03	1
S39063	USB/RS-232 Interface Board	USB/RS232	2
S39061	Printer Card	CPR-01	2
S38801	Data Card	USB	2
S38819	Ethernet Card	38818	1

Index

AC Withstand	39, 41, 43, 44, 45, 46, 50
Adapter Box.....	10, 20, 21, 48, 120
Alarm Parameter	29
Arc.....	3, 8, 15, 40, 41, 42, 44, 45, 52, 64, 65
Breakdown.....	3, 4, 52
Calibration .	11, 19, 21, 30, 31, 32, 33, 35, 36, 53, 108, 109, 110, 111, 112, 113, 114, 115, 116, 117, 118, 119
Calibration Alert	8
Alert Date	33, 67
Cal Alert.....	25, 32, 33, 35, 36, 37, 67
Cal Date.....	25, 33, 37, 67
Cal Due.....	25, 33, 37, 67
Date.....	19, 25, 33, 35, 37, 67
Time	15, 19, 25, 35, 37, 41, 44, 45, 46, 50, 64, 67
Charge-LO.....	41, 42, 45, 46, 52, 61, 62, 64
Connected Steps.....	23, 25, 28, 29, 30, 49, 61, 63, 68, 78, 88, 95, 109
Continuity Test.....	8, 20, 40, 46, 47, 48, 62
Contrast	19, 25, 29, 36, 37, 66
Controls.....	12, 14, 20, 21, 25, 71, 90
DC Withstand.....	41, 44, 45, 50, 52
Default Parameters	36, 39, 41, 63
Delay	17, 39, 42, 46, 56, 64, 65, 100
Dielectric Withstand Test	36, 39, 41, 42, 43, 44, 62, 63, 64, 65, 66, 68, 78, 89, 96, 99, 100
Discharge.....	7, 15
DUT	7, 8, 18, 32, 44, 45, 47, 48, 49, 52
Dwell.....	16, 18, 39, 41, 42, 44, 45, 47, 64, 65, 99, 100
Edit Parameters.....	27, 28, 29, 30, 33, 35, 37, 38, 39, 40, 41, 42, 43, 44, 45, 46, 47, 65, 66, 75
ESD	6, 7
Ethernet Card.....	80, 81, 82, 83, 84, 87, 88, 89, 90, 91, 120, 122
Exit Key.....	31, 52
Fail Stop.....	29, 62
Features.....	8, 91, 96
Frequency.....	3, 4, 14, 16, 39, 40, 41, 44, 47, 64, 66
Front Panel Controls.....	20
Glossary.....	3
GPIB.....	36, 58, 59, 60, 61, 67, 72, 73, 74, 78, 81, 120, 122
Insulation Resistance	45, 46
Interlock	9, 10, 19, 21, 48, 52, 56, 57, 68, 69, 120
LCD.....	19, 20, 29, 62, 68, 120
Leakage	4, 8, 12, 32, 44, 52, 74
Limits	39, 44, 45, 46, 47
Lock	31
Mem Lock.....	32
Lockout.....	14, 19, 48, 52, 56
Max Lmt	24, 39, 41, 42, 44
Max-Lmt.....	41, 42, 44, 45, 46, 47, 52, 64, 65

Medical Restrictions.....	7
Memory 19, 23, 24, 32, 37, 38, 40, 44, 49, 50, 52, 56, 60, 61, 62, 63, 66, 68, 69, 70, 71, 73, 75, 91, 92, 93, 97, 99, 100, 101, 102	
Menu... 8, 23, 25, 27, 28, 29, 30, 35, 37, 42, 43, 50, 51, 76, 77, 83, 84, 91, 92, 97, 98, 100, 101, 103	
Min Lmt	24, 39, 41, 42, 44
Min-Lmt	41, 42, 44, 45, 46, 47, 52, 64, 65, 66
Offset.....	8, 62
Operator.....	6, 7, 8, 9, 12, 13, 19, 21, 32, 44, 50, 55, 81
Options.....	19, 22, 35, 36, 39, 42, 58, 61, 74, 76, 83, 92, 103, 120
Parameters	
System Parameters	25, 78
Test Parameters.....	23, 41, 58, 60, 62, 78
Password.....	30, 31, 35
PLC.....	9, 25, 28, 36, 55
Power	4, 6, 12
Power Factor.....	4
Programming.....	23
Ramp-HI.....	41, 45, 64, 65
Ramping.....	8
Real Current.....	44, 50
Rear Panel Controls	12, 21
Receptacle.....	22, 48, 54
Regulation	16
Remote... 9, 19, 21, 25, 28, 36, 48, 51, 52, 54, 55, 56, 57, 58, 60, 66, 67, 68, 69, 74, 76, 78, 81, 103	
Remote Interlock	48, 52, 56, 57, 68
Resistance.....	4, 7, 12, 16, 17, 18, 39, 40, 46, 47, 50
Return.....	12
Reviewing Test Results.....	30
RS-232.....	i, 21, 58, 61, 69, 72, 73, 78, 80, 81, 89, 122
Safety	i, ii, 3, 5, 7, 11, 19
Safety Symbols.....	3
Scanner.....	8, 22, 41, 42, 66, 74, 81, 89, 91
Channel	44, 45, 46, 47
Internal.....	74
Option	74, 76
Parameter.....	39
Schematic.....	122
Setup.....	40
Status.....	75
Security	8, 19, 30, 31, 32, 35, 36, 37
Sequence.....	25, 28, 29, 30, 49, 61, 68, 78, 109
Service	1, 3, 5, 11, 60, 70, 71, 72, 108
Service Interval	5
Setup	8, 11, 20, 25, 27, 36, 37, 50, 62, 67, 77
AC Withstand.....	43
DC Withstand.....	44

File.....	62, 67
Ground Continuity.....	46
Insulation Resistance.....	45
Scanner.....	40, 74, 76
Setup System.....	84, 92
System.....	77
Test.....	37, 38
Short.....	16, 29, 40, 47, 52
Single Step.....	25, 28, 29, 36, 37, 66, 85, 86, 87, 89, 92
Smart GFI.....	19, 25, 32, 36, 37, 66
Specifications.....	14
System Parameters.....	25, 27, 36, 37, 66, 78
Test Parameters.....	23, 25, 41, 43, 44, 58, 60, 62, 78
Test Screen.....	77
Test Station.....	6, 7
Trip Point.....	39, 42, 44, 45, 46, 47, 52, 64, 65, 66
UL.....	103
Unpacking.....	10
Verification.....	19, 103, 104, 105, 106, 107
AC Hipot.....	104
Continuity.....	104
DC Hipot.....	105
IR.....	106
Warranty.....	1, 2, 108